

CATALOGUE

DENTAL INSTRUMENTS

Serving Your Health With Excellence



TOOTH EXTRACTING FORCEPS(ENG)



Incisors and Cuspids 1
RI-51001
Tooth Ext Forceps
Fig.1,

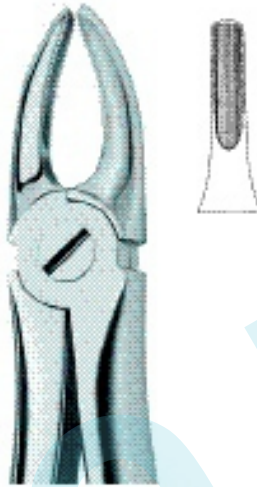

Incisors and Bicuspids 2
RI-51002
Tooth Ext Forceps
Fig.2,



Lower Incisors and Canines 4
RI-51004
Tooth Ext Forceps
Fig.4,

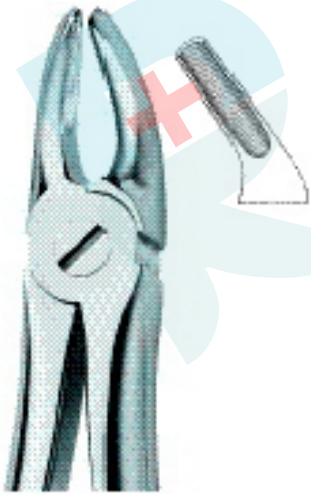

Bicuspids 7
RI-51007
Tooth Ext Forceps
Fig.7,



Lower Bicuspids, Universal 13
RI-51013
Tooth Ext Forceps
Fig.13,

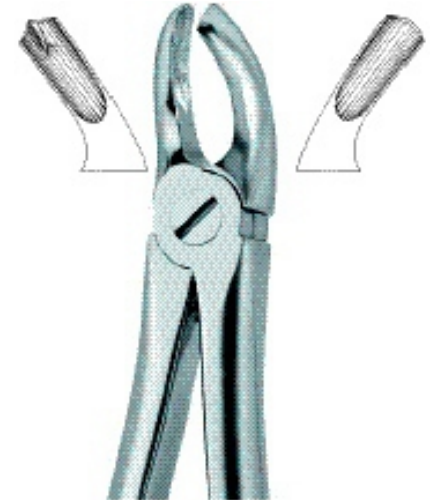

Molars, Right 17
RI-51017
Tooth Ext Forceps
Fig.17,

TOOTH EXTRACTING FORCEPS(ENG)

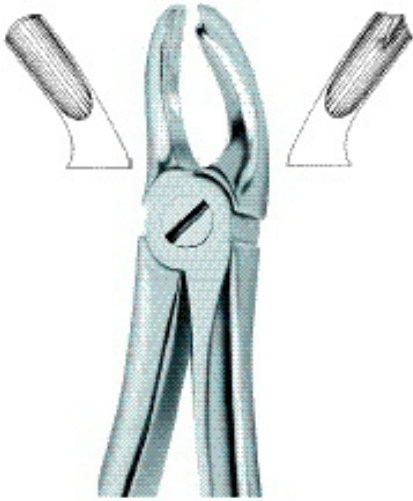

Molars, Left 18
RI-51018
Tooth Ext Forceps
Fig.18,

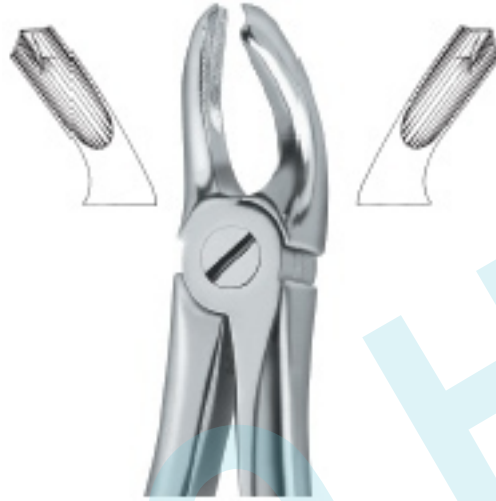

Molars 18A
RI-5101801
Tooth Ext Forceps
Fig.18A,



Lower Molars , Universal 22
RI-51022
Tooth Ext Forceps
Fig.22,

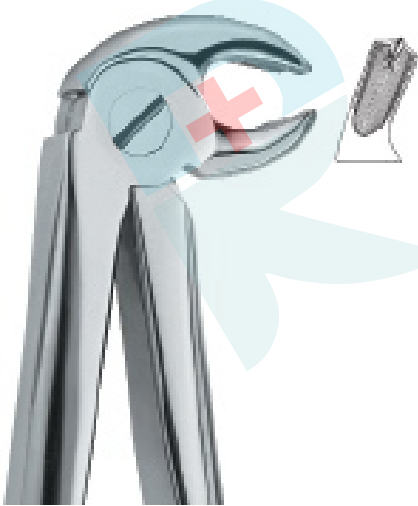

Lower Molars, Right 23
RI-51023
Tooth Ext Forceps
Fig.23,



Lower Molars, Left 24
RI-51024
Tooth Ext Forceps
Fig.24,



Upper roots and Incisors 29
RI-51029
Tooth Ext Forceps
Fig.29,

TOOTH EXTRACTING FORCEPS(ENG)



Lower Roots 33
RI-51033
Tooth Ext Forceps
Fig.33,



Lower Roots 01
RI-5103301
Tooth Ext Forceps
Fig.33 A,



Lower Roots 03
RI-5103303
Tooth Ext Forceps
Fig.33 C,



Lower Roots 06
RI-5103306
Tooth Ext Forceps
Fig.33 M,

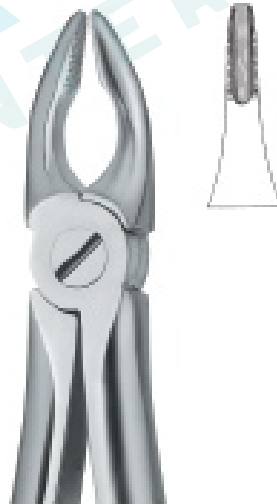

Incisors and Bicuspid 34N
RI-51034
Tooth Ext Forceps
Fig.34,



Incisors and Bicuspid 35N
RI-51035
Tooth Ext Forceps
Fig.35,

TOOTH EXTRACTING FORCEPS|(ENG)



RI-51036
Tooth Ext Forceps
Fig.36,



Lower roots 46
RI-51046
Tooth Ext Forceps
Fig.46,

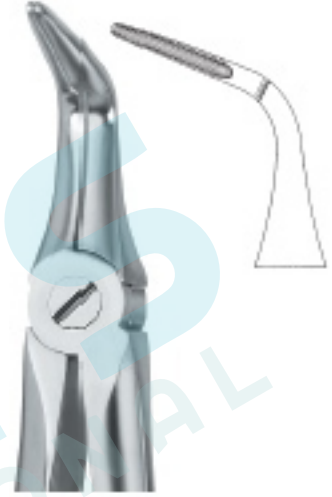

Lower Roots 46
RI-5104601
Tooth Ext Forceps
Fig.46 L,

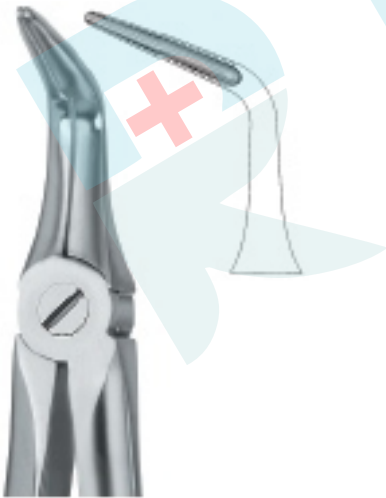

Lower Roots 46
RI-5104602
Tooth Ext Forceps
Fig.46 LX,



Very Fine Roots 49
RI-51049
Tooth Ext Forceps
Fig.49,



Roots 51
RI-51051
Tooth Ext Forceps
Fig.51,

TOOTH EXTRACTING FORCEPS(ENG)



Roots 51A
RI-5105101
Tooth Ext Forceps
Fig.51 A,



Roots 51 C
RI-5105103
Tooth Ext Forceps
Fig.51 C,

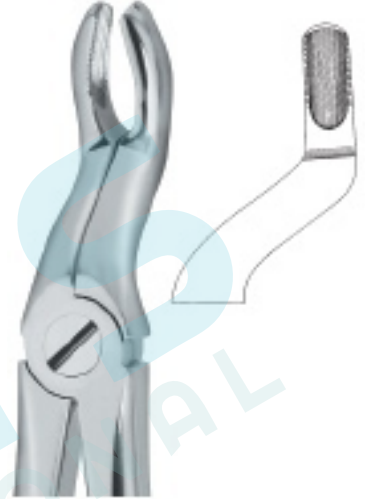

RI-51057
Tooth Ext Forceps
Fig.57,

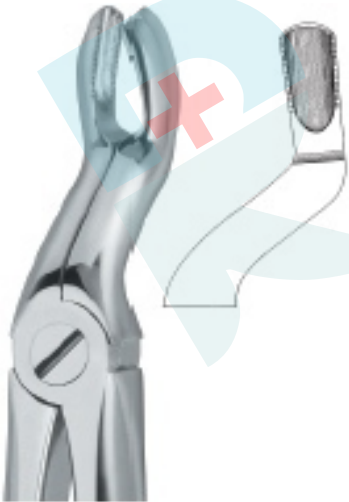

RI-510571
Tooth Ext Forceps
Fig.57 A,



RI-5105702
Tooth Ext Forceps
Fig.57 B,



Third Molars 67
RI-51067
Tooth Ext Forceps
Fig.67,

TOOTH EXTRACTING FORCEPS(ENG)



Third Molars 67 A
RI-5106701
Tooth Ext Forceps
Fig.67 A,



Third Molars Deep Gripping 67 N
RI-5106702
Tooth Ext Forceps
Fig.67 N,



Lower Molars 73
RI-51073
Tooth Ext Forceps
Fig.73,



Lower Roots 74
RI-51074
Tooth Ext Forceps
Fig.74,



Incisors and Roots 74N
RI-5107406
Tooth Ext Forceps
Fig.74 N,



Incisors and Roots ,Slender Jaw74XN
RI-5107407
Tooth Ext Forceps
Fig.74 XN,

TOOTH EXTRACTING FORCEPS(ENG)



Incisors and Bicuspids
RI-51075
Tooth Ext Forceps
Fig.75,



Upper Roots 76
RI-51076
Tooth Ext Forceps
Fig.76,

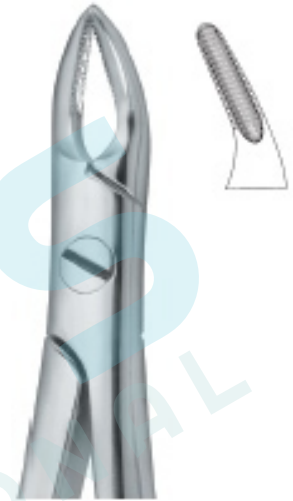

Upper Roots 76N
RI-5107607
Tooth Ext Forceps
Fig.76 N,

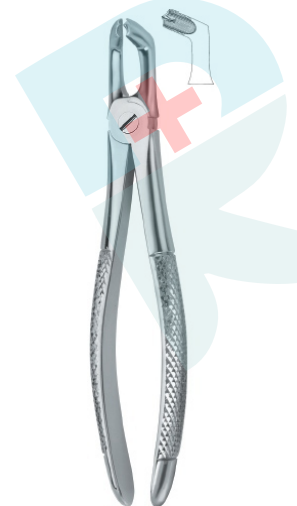

Third Molars 79
RI-51079
Tooth Ext Forceps
Fig.79,



Third Molars 79A
RI-5107901
Tooth Ext Forceps
Fig.79 A,

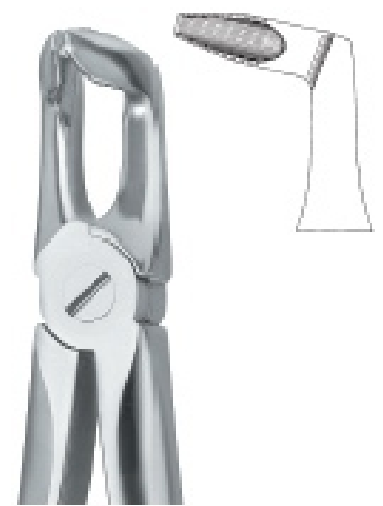

Third Molars ,Deep Gripping 79N
RI-5107902
Tooth Ext Forceps
Fig.79 N,

TOOTH EXTRACTING FORCEPS(ENG)



Molars with carious or broken caps 86A
RI-5108601

Tooth Ext Forceps
Fig.86 A,



Molars with carious or broken caps 86B
RI-5108602

Tooth Ext Forceps
Fig.86 B,



Molars with carious or broken caps 86C
RI-5108603

Tooth Ext Forceps
Fig.86 C,

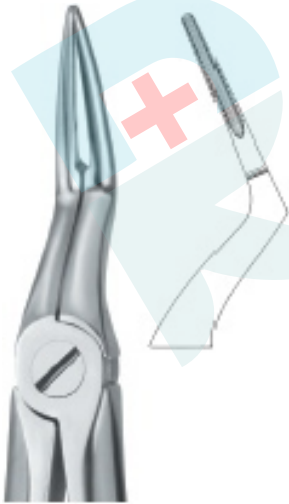

RI-51097
Tooth Ext Forceps
Fig.97,



Very Fine Roots 133
RI-51133
Tooth Ext Forceps
Fig.133,



Roots Fragments, Deep Gripping 146
RI-51146
Tooth Ext Forceps
Fig.146,

TOOTH EXTRACTING FORCEPS(ENG)



Tooth Ext Forceps
RI-51151
Tooth Ext Forceps
Fig.151,



Tooth Ext Forceps
RI-51153
Fig.153,



Roots, with Parallel beak 233
RI-51233
Tooth Ext Forceps
Fig.233,



Incisors and Bicuspid 1
RI-51301
Tooth Ext Forceps
Fig.1,



Incisors and Bicuspid 2
RI-51302
Tooth Ext Forceps
Fig.2,



Bicuspid 7
RI-51307
Tooth Ext Forceps
Fig.7,

TOOTH EXTRACTING FORCEPS(ENG)



Bicuspid 13
RI-51313
Tooth Ext Forceps
Fig.13,

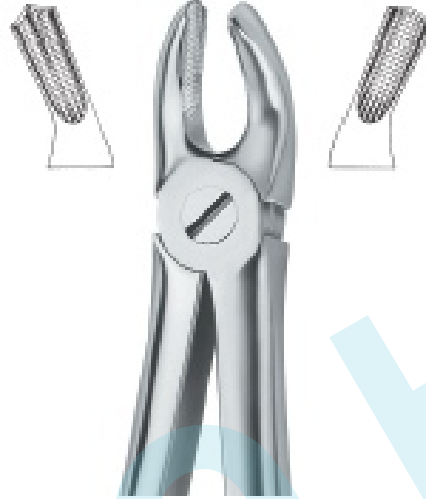

Molars 17
RI-51317
Tooth Ext Forceps
Fig.17,

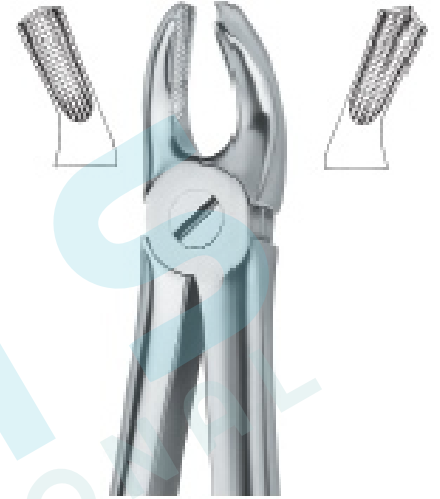

Molars 18
RI-51318
Tooth Ext Forceps
Fig.18,



Molars 22
RI-51322
Tooth Ext Forceps
Fig.22,



Roots 33
RI-51330
Tooth Ext Forceps
Fig.30,



Roots 33
RI-51333
Tooth Ext Forceps
Fig.33,

TOOTH EXTRACTING FORCEPS(ENG)



Roots 51
RI-51351
Tooth Ext Forceps
Fig.51,



Roots, Very Fine Beak 51A
RI-5135101
Tooth Ext Forceps
Fig.51 A,

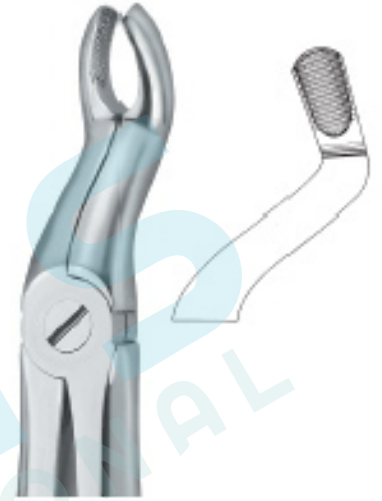

Third Molars 67 A
RI-5136701
Tooth Ext Forceps
Fig.67 A,

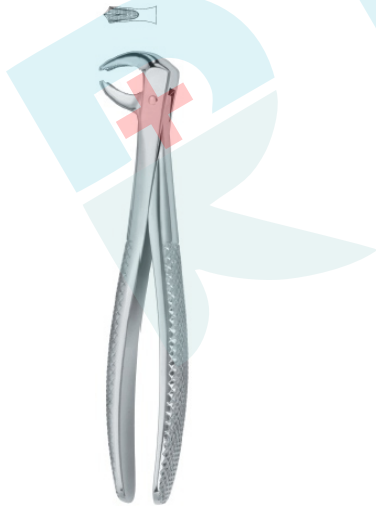

Molars 73
RI-51373
Tooth Ext Forceps
Fig.73,



Incisors and Roots 74
RI-51374
Tooth Ext Forceps
Fig.74,



Incisors and roots , with fine beak 74N
RI-5137401
Tooth Ext Forceps
Fig.74 N,

TOOTH EXTRACTING FORCEPS(ENG)

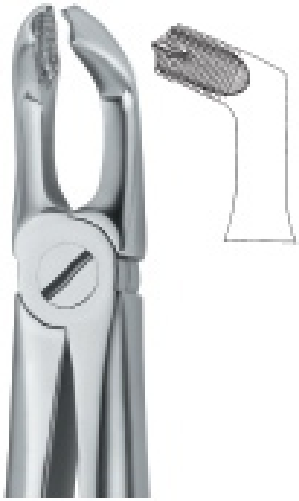

Third Molars 79
RI-51379
Tooth Ext Forceps
Fig.79,



Incisors and cuspids 1
RI-51401
Tooth Ext Forceps
Fig.1 Diam,

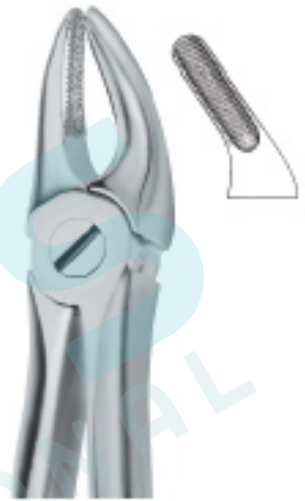

Bicuspid 7
RI-51407
Tooth Ext Forceps
Fig.7 Diam,



Incisors and cuspids 13
RI-51413
Tooth Ext Forceps
Fig.13 Diam,

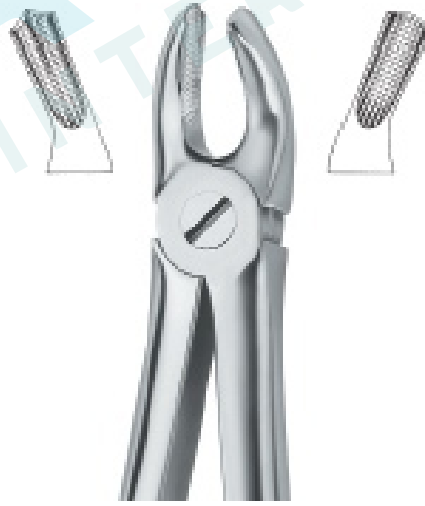

Molars , Right 17
RI-51417
Tooth Ext Forceps
Fig.17 Diam,



Molars , left 18
RI-51418
Tooth Ext Forceps
Fig.18 Diam,

TOOTH EXTRACTING FORCEPS|(ENG)



Molars 22
RI-51422
Tooth Ext Forceps
Fig.22 Diam,



Roots 33
RI-51433
Tooth Ext Forceps
Fig.33 Diam,



Very Fine Roots 46
RI-51446
Tooth Ext Forceps
Fig.46 Diam,

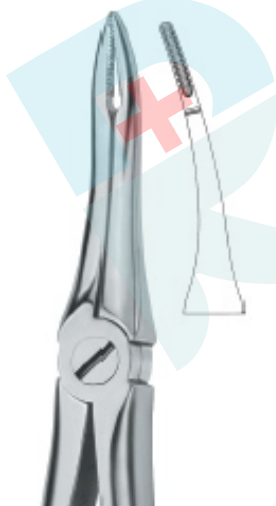

Very Fine Roots 49
RI-51449
Tooth Ext Forceps
Fig.49 Diam,



Roots 51
RI-51451
Tooth Ext Forceps
Fig.51 Diam,



Roots , With Fine Beak 51A
RI-5145101
Tooth Ext Forceps
Fig.51 A Diam,

TOOTH EXTRACTING FORCEPS(ENG)



Martin Ergo 67A
RI-5146701
Tooth Ext Forceps
Fig.67 A Diam,



Martin Ergo 74N
RI-51474
Tooth Ext Forceps
Fig.74 N Diam,



Martin Ergo 79
RI-51479
Tooth Ext Forceps
Fig.79 Diam,



Bicuspid 13S
RI-5161309
Tooth Ext Forceps
Fig.13 S,



Molars 22s
RI-5162209
Tooth Ext Forceps
Fig.22 S,

TOOTH EXTRACTING FORCEPS(ENG)



Incisors and Roots 30S
RI-5163009
Tooth Ext Forceps
Fig.30 S,



Roots 33S
RI-5163309
Tooth Ext Forceps
Fig.33 S,



Incisors and bicuspid 37
RI-51637
Tooth Ext Forceps
Fig.37,



Incisors and Cuspid 38
RI-51638
Tooth Ext Forceps
Fig.38,



Molars 39
RI-51639
Tooth Ext Forceps
Fig.39,



Molars 39A
RI-5163901
Tooth Ext Forceps
Fig.39 A,

TOOTH EXTRACTING FORCEPS(ENG)



Incisors 5
RI-51705
Tooth Ext Forceps
Fig.5,



Molars 6
RI-51706
Tooth Ext Forceps
Fig.6,

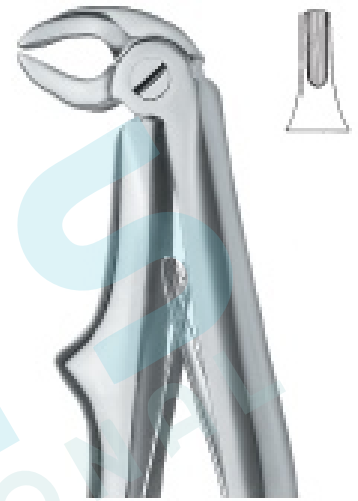

Roots 7
RI-51707
Tooth Ext Forceps
Fig.7,

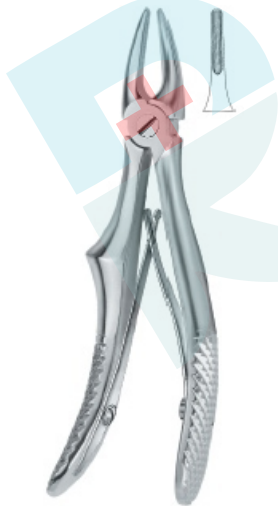

Incisors and cuspids 137
RI-51737
Tooth Ext Forceps
Fig.137,



Bicuspid 139
RI-51739
Tooth Ext Forceps
Fig.139,



Klein , Roots 51S
RI-5175109
Tooth Ext Forceps
Fig.51 S,

TOOTH EXTRACTING FORCEPS(ENG)



Molars , Left 39L
RI-5163905
Tooth Ext Forceps
Fig.39 L,



Molars , Right 39R
RI-5163908
Tooth Ext Forceps
Fig.39 R,



Molars 40
RI-51640
Tooth Ext Forceps
Fig.40,



Roots 51S
RI-5165109
Tooth Ext Forceps
Fig.51 S,



Roots 76S
RI-5167609
Tooth Ext Forceps
Fig.76 S,



Molars 3
RI-51703
Tooth Ext Forceps
Fig.3,

TOOTH EXTRACTING FORCEPS|(ENG)



Molars 17SK
RI-5181709
Tooth Ext Forceps
Fig.17 SK,



Molars 23SK
RI-5182309
Tooth Ext Forceps
Fig.23 SK,



Teeth and Roots ,Universal 150SK
RI-5185009
Tooth Ext Forceps
Fig.150 SK,



Teeth and Roots, Universal 151Sk
RI-5185109
Tooth Ext Forceps
Fig.151 SK,

TOOTH EXTRACTING FORCEPS|(AMR)



Incisors and Bicuspid 1
RI-52001
Tooth Ext Forceps Amr
Fig.1,



Henahan Incisors 1A
RI-5200101
Tooth Ext Forceps Amr
Fig.1 A,

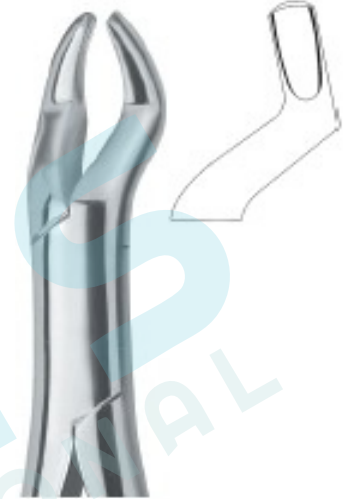

Molars and third molars 10S
RI-5201009
Tooth Ext Forceps Amr
Fig.10 S,



Molars 15
RI-52015
Tooth Ext Forceps Amr
Fig.15,



Molars 16
RI-52016
Tooth Ext Forceps Amr
Fig.16,



Molars , Slender Jaw
RI-5201609
Tooth Ext Forceps Amr
Fig.16 S,

TOOTH EXTRACTING FORCEPS|(AMR)



Molars , Left 53L
RI-5205305
Tooth Ext Forceps Amr
Fig.53 L,

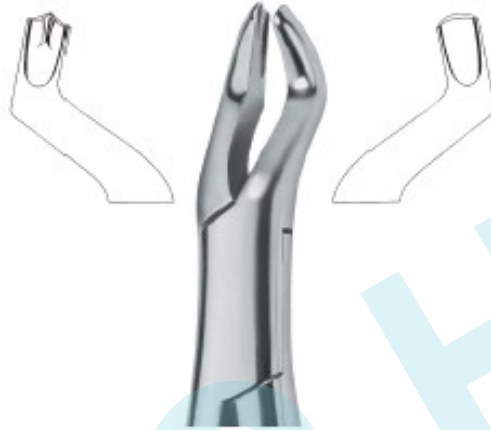

Molars , Right 53R
RI-5205308
Tooth Ext Forceps Amr
Fig.53 R,



Teeth and Roots, Universal also for
Children 62
RI-52062
Tooth Ext Forceps Amr
Fig.62,



Incisors and Roots 65
RI-52065
Tooth Ext Forceps Amr
Fig.65,



Tomes Roots Fragments and Small Roots
69
RI-52069
Tooth Ext Forceps Amr
Fig.69,



Nevius Molars , Left 88L
RI-5208805
Tooth Ext Forceps Amr
Fig.88 L,

TOOTH EXTRACTING FORCEPS (AMR)



Molars 17
RI-52017
Tooth Ext Forceps Amr
Fig.17,

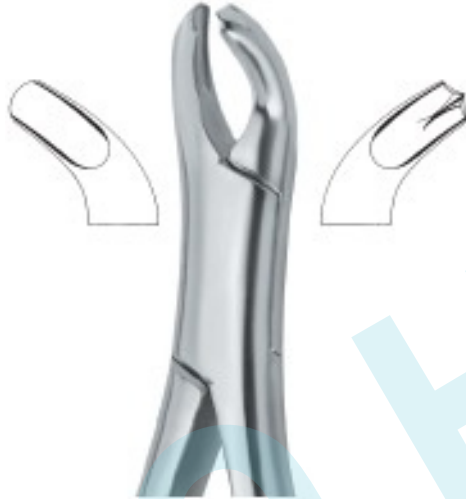

Harris Molars , left 18L
RI-5201805
Tooth Ext Forceps Amr
Fig.18 L,

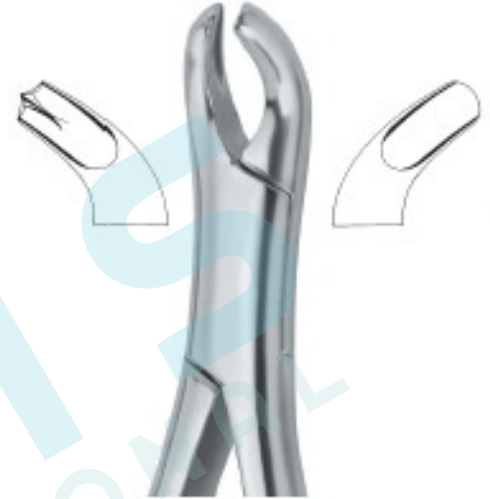

Harris Molars , Right 18R
RI-5201808
Tooth Ext Forceps Amr
Fig.18 R,

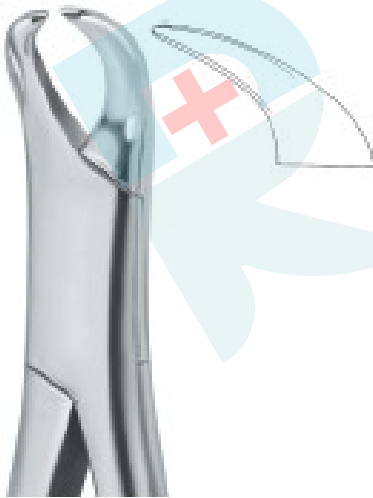

Molars
RI-52023
Tooth Ext Forceps Amr
Fig.23,



Parmlly Molars and bicuspid 32
RI-52032
Tooth Ext Forceps Amr
Fig.32,



Parmlly Molars and Bicuspid , Roots 32A
RI-5203201
Tooth Ext Forceps Amr
Fig. 32 A,

TOOTH EXTRACTING FORCEPS (AMR)



Cryer Bicuspid, Incisors and Roots 151
RI-52151

Tooth Ext Forceps Amr
Fig.151,



Cryer Bicuspid, Incisors and Roots 151A
RI-5215101

Tooth Ext Forceps Amr
Fig.151 A,

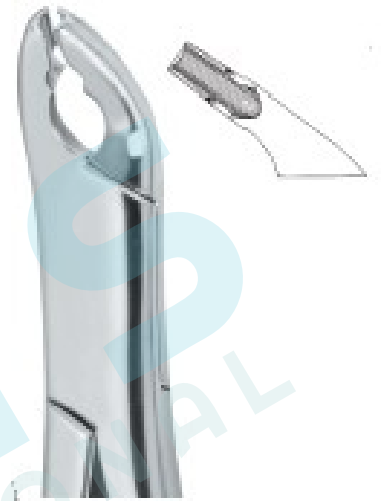

Cryer Bicuspid, Incisors and Roots 151X
RI-5215102

Tooth Ext Forceps Amr
Fig.151 X,



Bicuspid and Incisors, Roots 151AS
RI-5215108

Tooth Ext Forceps Amr
Fig.151 RI-,



Cryer Teeth and Roots, Universal 151S
RI-5215109

Tooth Ext Forceps Amr
Fig.151 S,



Third Molars 222
RI-52222
Tooth Ext Forceps Amr
Fig.222,

TOOTH EXTRACTING FORCEPS (AMR)



Nevius Molars , Right 88R
RI-5208808
Tooth Ext Forceps Amr
Fig.88 R,



Cryer Bicuspid , Incisors and Roots 150
RI-52150

Tooth Ext Forceps Amr
Fig.150,



Cryer Bicuspid , Incisors and Roots 150A
RI-5215001

Tooth Ext Forceps Amr
Fig.150 A,



Bicuspid and Incisor , Roots 150X
RI-5215002

Tooth Ext Forceps Amr
Fig.150 X,



Bicuspid and Incisor, Roots 150AS
RI-5215008

Tooth Ext Forceps Amr
Fig.150 RI-



Cryer Bicuspid and Incisor , Roots 150S
RI-5215009

Tooth Ext Forceps Amr
Fig.150 S,

ROOT ELEVATORS



Seldin 1L
RI-5300105
Root Elevators
Fig.1L,



Seldin 1R
RI-5300108
Root Elevator
Fig.1R,

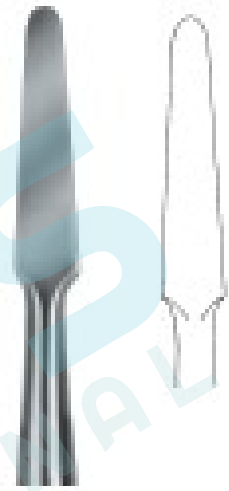

Seldin 2
RI-5300200
Root Elevators
Fig.2,



Seldin
RI-5300300
Root Elevators
Fig.3,

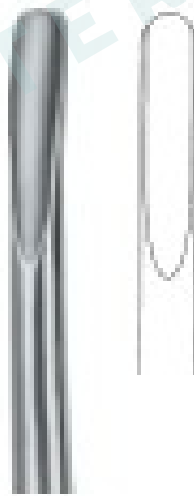

Cryer
RI-5300301
Root Elevators
Fig.3 A,



Seldin 4L
RI-5300405
Root Elevators
Fig. 4 L,

TOOTH EXTRACTING FORCEPS|(AMR)



Root Fragments and Universal 501
RI-52501

Tooth Ext Forceps Amr
Fig.501,



Witzel Root Fragments and Universal 502
RI-52502

Tooth Ext Forceps Amr
Fig.502,

ROOT ELEVATORS



Seldin 4R
RI-5300408
Root Elevators
Fig. 4 R,



Crane Pick 6
RI-5300600
Root Elevators
Fig. 6,

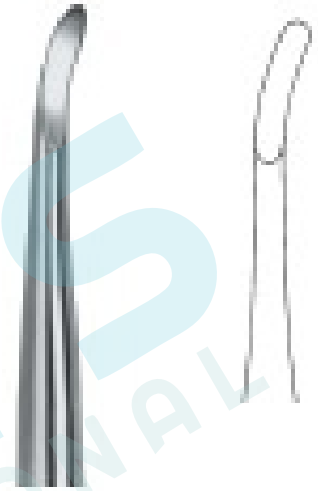

Miller 1
RI-5300800
Root Elevators
Fig. 8,

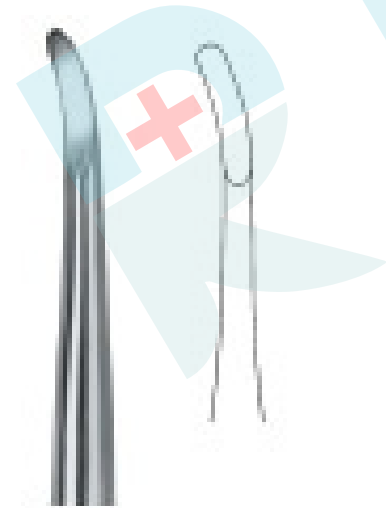

Miller 2
RI-5300900
Root Elevators
Fig.9,



MillerApexo
RI-5301000
Root Elevators
Fig.10,



MillerApexo
RI-5301100
Root Elevators
Fig.11,

ROOT ELEVATORS



Cryer
RI-5301200
Root Elevators
Fig.12,



Cryer
RI-5302700
Root Elevators
Fig.27,

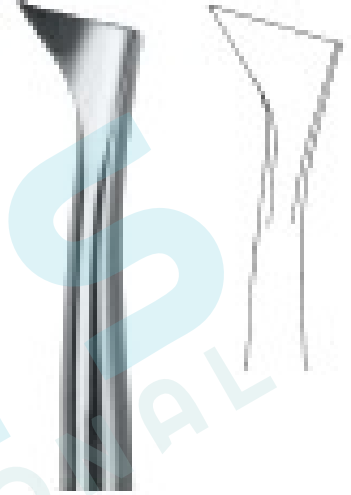

Cryer 28
RI-5302800
Root Elevators
Fig.28,

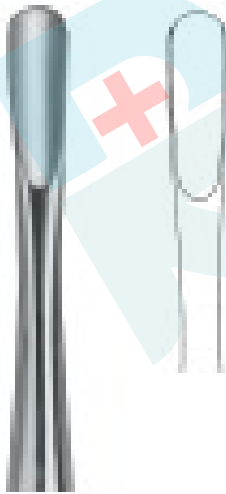

Seldin 34
RI-5303400
Root Elevators
Fig.34,

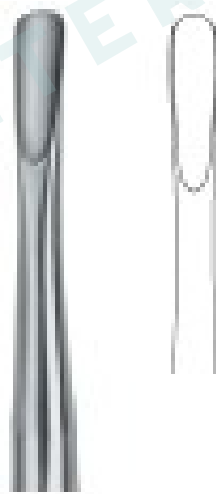

Seldin 34S
RI-5303409
Root Elevators
Fig.34 S,



Cryer 27S
RI-5303900
Root Elevators
Fig. 39,

ROOT ELEVATORS



Cryer 28S
RI-5304000
Root Elevators
Fig. 40,

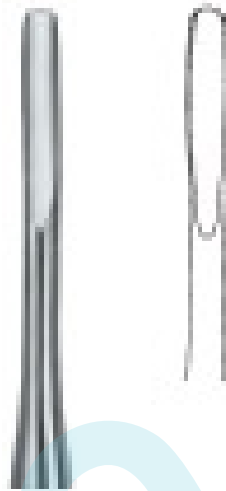

Flohr
RI-5304600
Root Elevators
Fig. 46,



Barry 50
RI-5305000
Root Elevators
Fig. 50,



Barry 51
RI-5305100
Root Elevators
Fig. 51,



Lindo Levian 1
RI-5320001
Root Elevators
Fig. 1,



Lindo Levian 3
RI-5320003
Fig. 3,

ROOT ELEVATORS



HowardApexo # 1
RI-5320400
Root Elevators
Fig. 1,



RI-5320401
Root Elevators
Fig. 1,



Root Elevators
RI-5320500
Fig. 1,

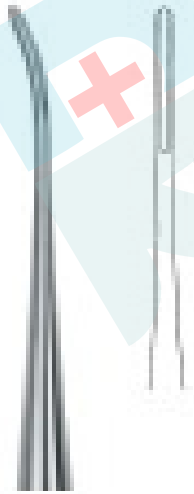

Root Elevators
RI-5320501
Fig. 1,



Bein 1
RI-5322001
Root Elevator
fig. 2,

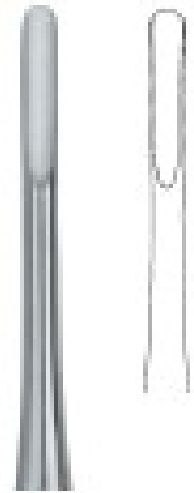

Bein 2
RI-5322002
Root Elevator
Fig. 3,

ROOT ELEVATORS

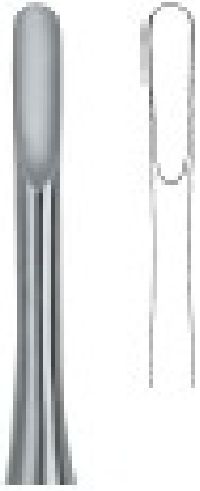

Bein 3
RI-5322003
Root Elevator
Fig. 3,

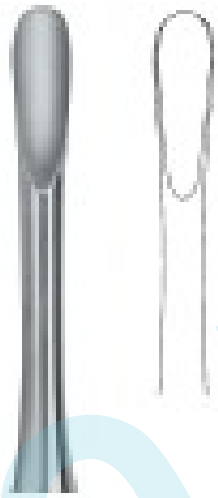

Bein 4
RI-5322004
Fig. 4,

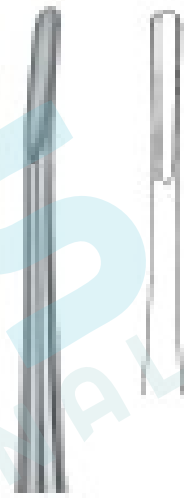

Bein 1A
RI-5322101
Fig. 1 A,



Bein 2A
RI-5322102
Fig. 2 A,

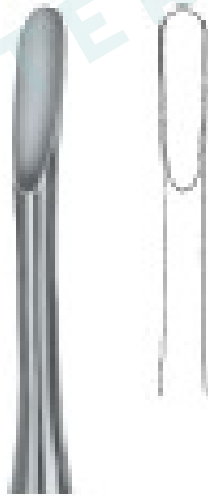

Bein 3A
RI-5322103
Fig. 3 A,

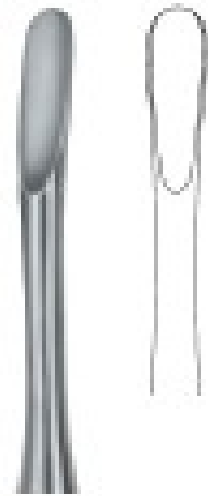

Bein 4A
RI-5322104
Fig. 4 A,

ROOT ELEVATORS



Apical 1
RI-5322201
Fig. 1,

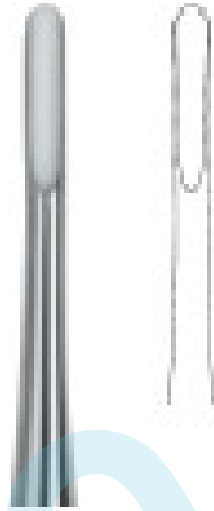

Apical 2
RI-5322202
Fig. 2,

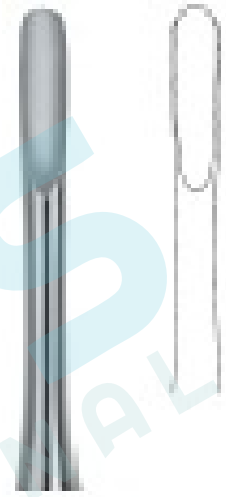

Apical 3
RI-5322203
Fig. 3,

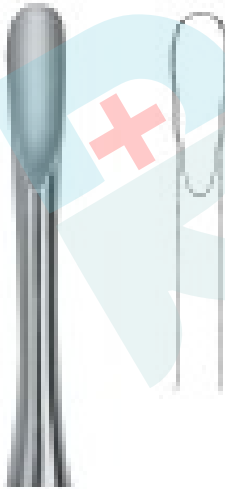

Apical 4
RI-5322204
Fig. 4,



Apical 1A
RI-5322301
Fig. 1 A,



Apical 2A
RI-5322302
Fig. 2 A,

ROOT ELEVATORS

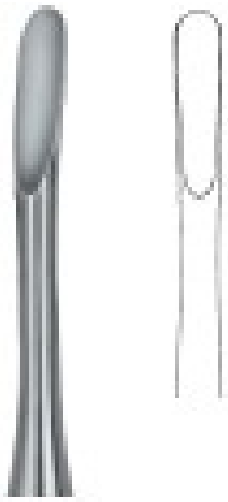

Apical 3A
RI-5322303
Fig. 3 A,



Apical 4A
RI-5322304
Fig. 4 A,

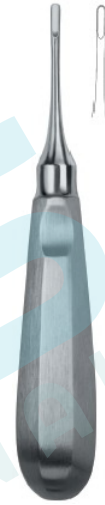

Apical 301
RI-5330100
Root Elevators
Fig. 301,

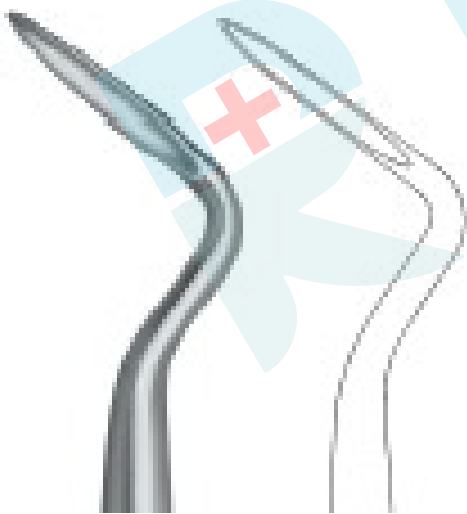

Apical 302
RI-5330200
Root Elevators
Fig. 302,



ApicalFlohr
RI-5330300
Root Elevators
Fig. 303,

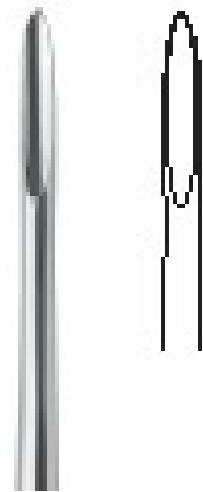

Apical 304
RI-5330400
Root Elevators
Fig. 304,

ROOT ELEVATORS

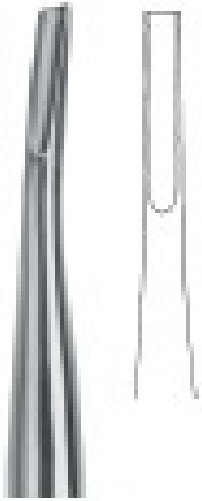

Coupland Bone chisels 3
RI-5341503
Root Elevators
Fig. 3,



Friedman 1
RI-5350501
Root Elevators
Fig. 1,

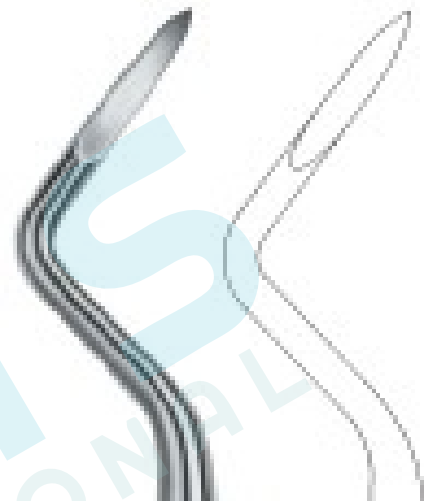

Friedman 2L
RI-5350502
Root Elevators
Fig. 2 L,

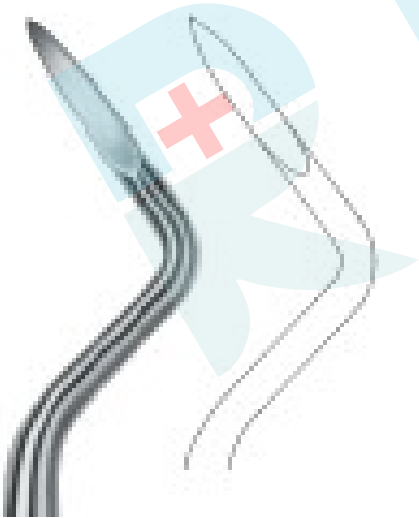

Friedman 2R
RI-5350503
Root Elevators
Fig. 3 R,



Hysin 1
RI-5350801
Root Elevators
Fig. 1,

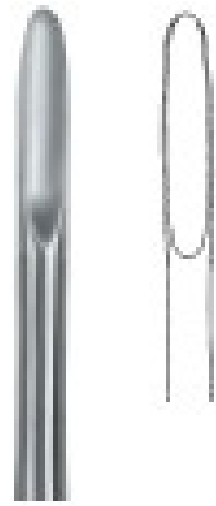

Hysin 2
RI-5350802
Root Elevators
Fig. 2,

ROOT ELEVATORS

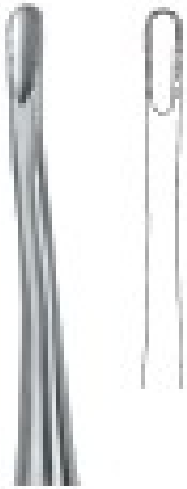

Apical 46R
RI-5331100
Root Elevators
Fig. 46 R,



Coleman
RI-5340501
Root Elevators
Fig. 1,



Coleman 2L
RI-5340502
Root Elevators
Fig. 2 L,

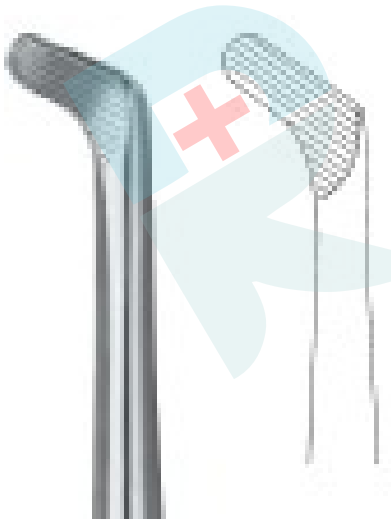

Coleman 3R
RI-5340503
Root Elevators
Fig. 3 R,



Coupland Bone chisels 1
RI-5341501
Root Elevators
Fig. 1,



Coupland Bone Chisels 2
RI-5341502
Root Elevators
Fig. 2,

ROOT ELEVATORS

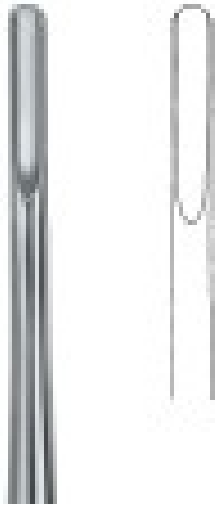

Bein 1
RI-5351201
Root Elevators
Fig. 1,

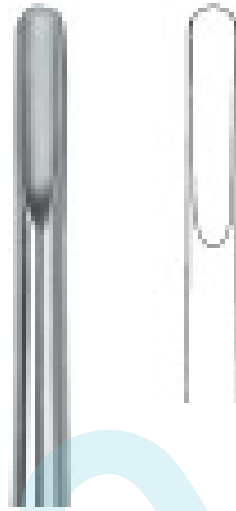

Bein 2
RI-5351202
Root Elevators
Fig. 2,



Bein 0
RI-5351300
Root Elevators
Fig. 0,

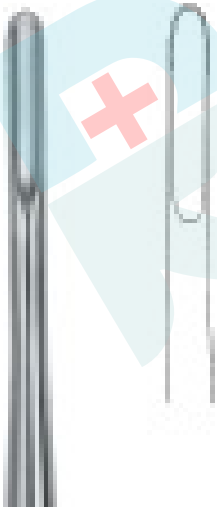

Bein 1
RI-5351301
Root Elevators
Fig. 1,

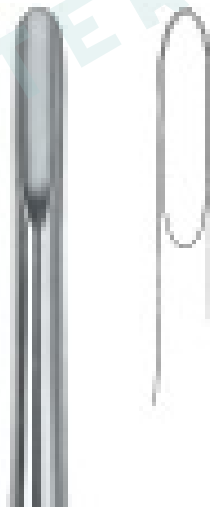

Bein 2
RI-5351302
Root Elevators
Fig. 2,



Bein 0A
RI-5351400
Root Elevators
Fig. 0 A,

ROOT ELEVATORS

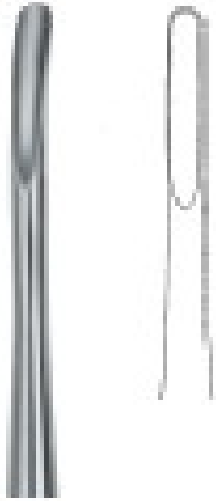

Bein 1A
RI-5351401
Root Elevators
Fig. 1 A,

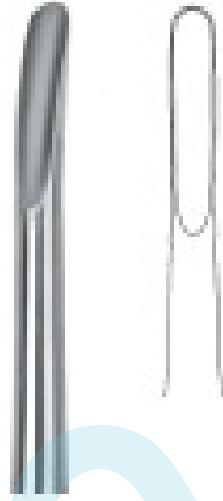

Bein 2A
RI-5351402
Root Elevators
Fig. 2 A,

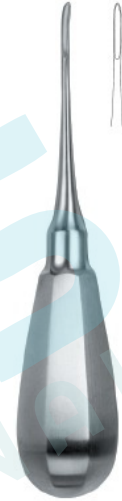

Bein 0A
RI-5351500
Root Elevators
Fig. 0 A,

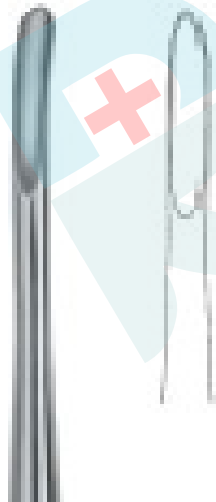

Bein 1A
RI-5351501
Root Elevators
Fig. 1 A,

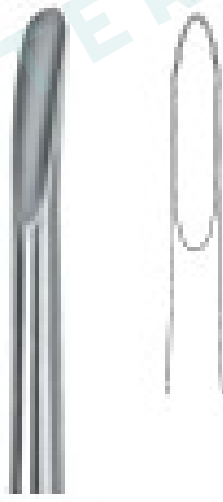

Bein 2A
RI-5351502
Root Elevators
Fig. 2 A,



W.F. Barry 320L
RI-5353320
Root Elevators
Fig. 320 L,

ROOT ELEVATORS



W.F. Barry 321R
RI-5353321
Root Elevators
Fig. 321 R,



Barry 322
RI-5353322
Root Elevators
Fig. 322,



Barry 323
RI-5353323
Root Elevators
Fig. 323,



W.F. Barry 370R
RI-5353370
Root Elevators
Fig. 370 R,



W.F. Barry 371R
RI-5353371
Root Elevators
Fig. 371 R,



Winter 11L
RI-5355105
Root Elevators
Fig. 11 L,

ROOT ELEVATORS



Hyllin 3L
RI-5350803
Root Elevators
Fig. 3 L,

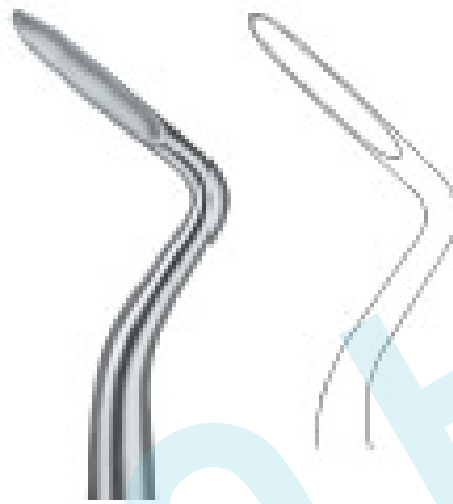

Hyllin 4R
RI-5350804
Root Elevators
Fig. 4 R,



Bein 0
RI-5351100
Root Elevators
Fig. 0,

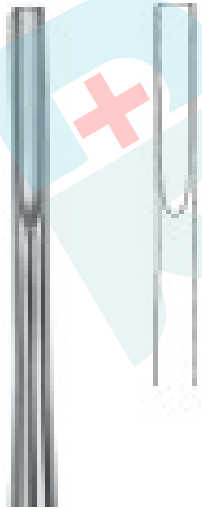

Bein 1
RI-5351101
Root Elevators
Fig. 1,

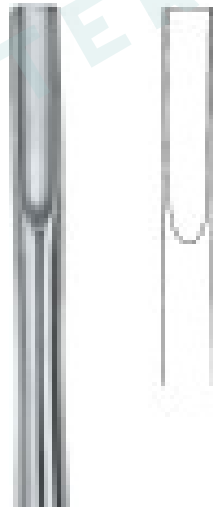

Bein 2
RI-5351102
Root Elevators
Fig. 2,



Bein
RI-5351200
Root Elevators
Fig. 0,

ROOT ELEVATORS



Winter 11R
RI-5355108
Root Elevators
Fig. 11 R,



Winter 13L
RI-5355305
Root Elevators
Fig. 13 L,

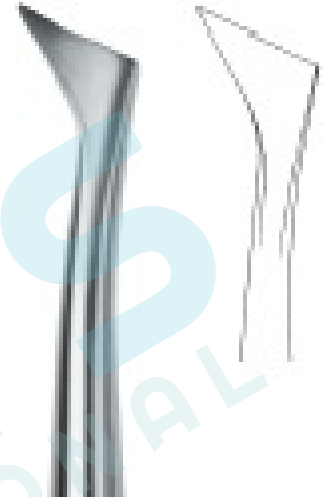

Winter 13R
RI-5355308
Root Elevators
Fig. 13 R,

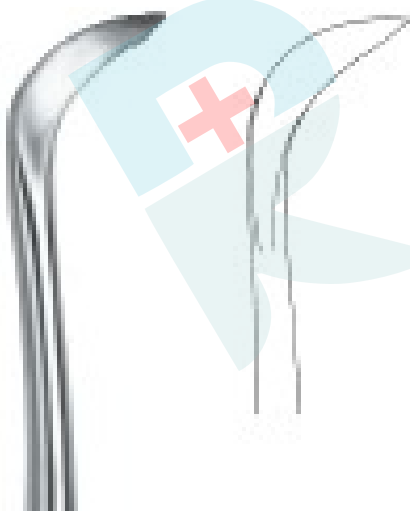

Winter 14L
RI-5355405
Root Elevators
Fig. 14 L,



Winter 14R
RI-5355408
Root Elevators
Fig. 14 R,

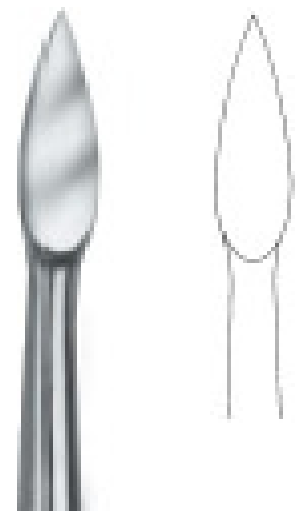

Lecluse 1
RI-5356101
Root Elevators
Fig. 1,

ROOT ELEVATORS



WarwickJames 3R
RI-5357603
Root Elevators
Fig. 3 R,

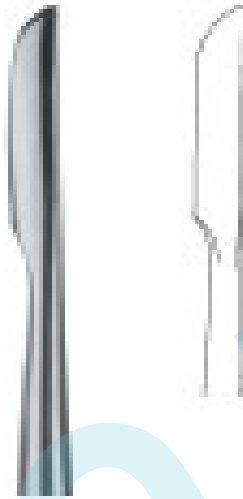

Chompret 1
RI-5357701
Root Elevators
Fig. 1,

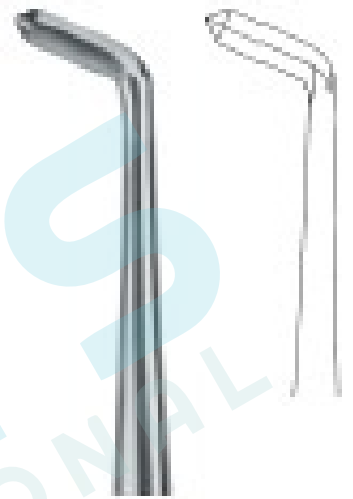

Chompret 2
RI-5357702
Root Elevators
Fig. 2,

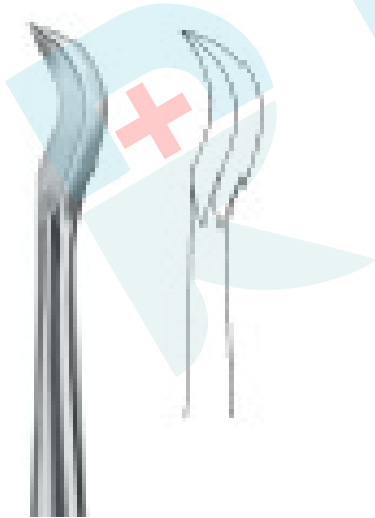

Chompret 3
RI-5357703
Root Elevators
Fig. 3,



Heidebrink 1
RI-5358201
Root Elevators
Fig. 1,



Heidebrink 2
RI-5358202
Root Elevators
Fig. 2,

ROOT ELEVATORS

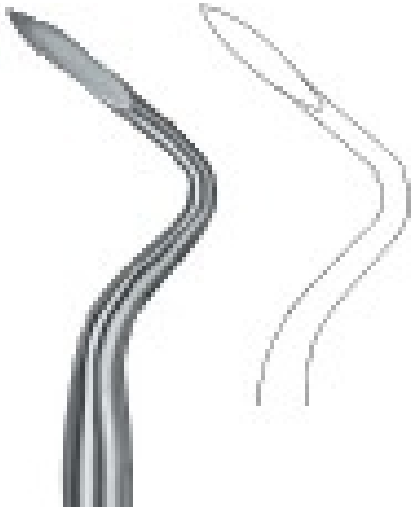

Heidebrink 3
RI-5358203
Root Elevators
Fig. 3,



West 1
RI-5358401
Root Elevators
Fig. 1,

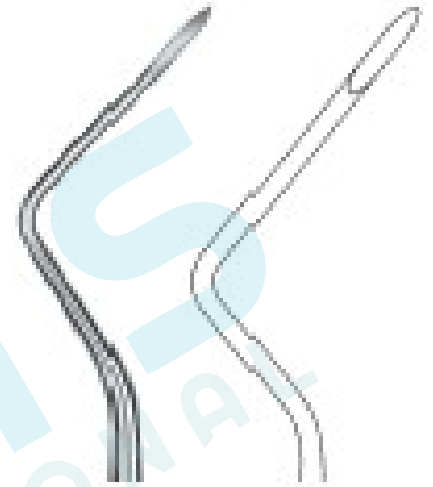

West 2
RI-5358402
Root Elevators
Fig. 2,

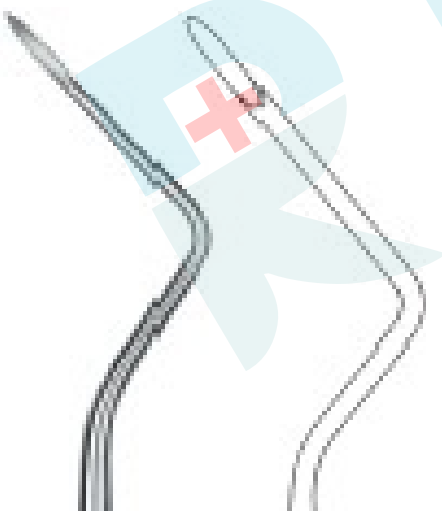

West 3
RI-5358403
Root Elevators
Fig. 3,

ROOT ELEVATORS



Pott 1
RI-5356701
Root Elevators
Fig. 1,



Pott 2
RI-5356702
Root Elevators
Fig. 2,

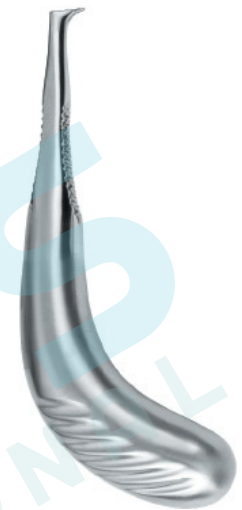

Krallenheber 1L
RI-5357101
Root Elevators
Fig. 1 L,

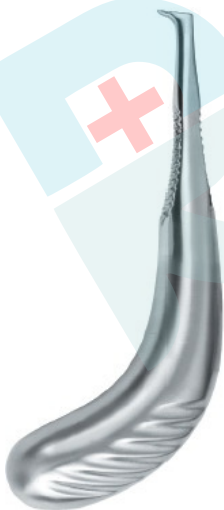

Krallenheber 2R
RI-5357102
Root Elevators
Fig. 2 R,



WarwickJames 1
RI-5357601
Root Elevators
Fig. 1,



WarwickJames 2L
RI-5357602
Root Elevators
Fig. 2 L,

BONE RONGEURS



Bone Rongeur
RI-54101
Bone Holding Forceps
185 mm, 7 1/2",



Bone Rongeur
RI-54102
Bone Holding Forceps
185 mm, 7 1/2",



Bone Rongeur
RI-54103
Bone Holding Forceps
200 mm, 8",



Bone Rongeur
RI-54104
Bone Holding Forceps
215 mm, 8 1/2",



FriedmanMicro 6"
RI-54106
Bone Rongeurs
150 mm, 6",

BONE RONGEURS



FriedmanMicro 5"
RI-54107
Bone Rongeurs
145 mm, 5 1/4",



Bone Rongeur
RI-54108
Bone Rongeurs
140 mm, 5 1/2",

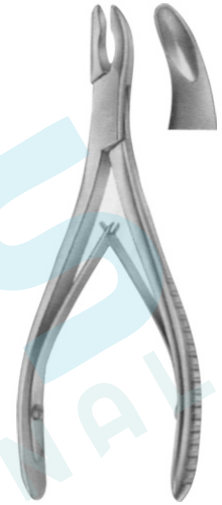

LUER 6"
RI-54109
Bone Rongeurs
150 mm, 6",



LUER 6"
RI-54110
Bone Rongeurs
155 mm, 6",



2AMEAD, SQUARE TIPS 5"
RI-54111
Bone Rongeur
145 mm, 5",



BLUMENTHAL 6"
RI-54112
Bone Rongeur
155 mm, 6",

BONE RONGEURS



BLUMENTHAL 45° 6"
RI-54113
Bone Rongeur
150 mm,6,



Bone Rongeur 7"
RI-54114
Bone Rongeur
175 mm,7",



Bone Rongeur
RI-54115
Bone Rongeur
170 mm,6.5",



BEYER 7"
RI-54116
Bone Rongeur
180 mm,7",



MEAD 6½"
RI-54117
Bone Rongeur
165 mm,6½",



BANEHEARTMANN 7"
RI-54118
Bone Rongeur
175 mm,7",

BONE FILES



Fig. 1
Polokoff

Polokoff
RI-55101
Bone Files
Fig 1,



Fig. 33

RI-55102
Bone Files
Fig 33,

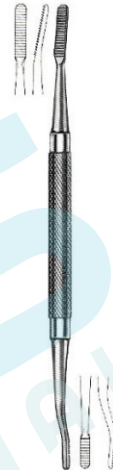

Fig. 64
Miler

Miler
RI-55103
Bone Files
Fig 64,



Fig. 45
Miler

Miler
RI-55104
Bone Files
Fig 45,



Fig. 10

RI-55105
Bone Files
Fig 10,



Fig. 1
Wahl

Wahl
RI-55106
Bone Files
Fig 1,

BONE RONGEURS



BEYER DOUBLEACTION 7"
RI-54119
Bone Rongeur
180 mm, 7",



ZUFALJANSEN 7"
RI-54120
Bone Rongeur
180 mm, 7",



Bone Rongeur
RI-54121
Bone Rongeur
130 mm, 5 1/8",



Bone Rongeur
RI-54122
Bone Rongeur
130 mm, 5 1/8",



Cleveland 5"
RI-54123
Bone Cutting Forceps
130 mm, 5",



Bone Rongeur
RI-54124
Bone Cutting Forceps
150 mm, 6",

BONE FILES



Fig. 2
Wahl
Wahl
RI-55107
Bone Files
Fig 2,



Fig. 12CA
RI-55108
Bone Files
Fig 12CA,



Fig. 12A
RI-55109
Bone Files
Fig 12A,

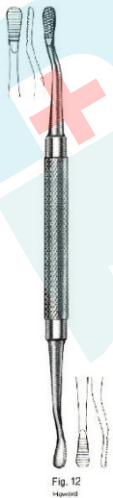

Fig. 12
Howard
Howard
RI-55110
Bone Files
Fig 12,

BONE CURETTES



Fig 1
Hemingway

Hemingway
RI-56101
Bone Curettes
Fig 1,



Fig 2
Hemingway

Hemingway
RI-56102
Bone Curettes
Fig 2,



Fig 3
Hemingway

Hemingway
RI-56103
Bone Curettes
Fig 3,



Fig 4
Hemingway

Hemingway
RI-56104
Bone Curettes
Fig 4,



Fig 85
Lucas

Lucas
RI-56105
Bone Curettes
Fig 85,



Fig 86
Lucas

Lucas
RI-56106
Bone Curettes
Fig 86,

BONE CURETTES



Fig. 87
Lucas

Lucas
RI-56107
Bone Currettes
Fig 87,



Fig. 88
Lucas

Lucas
RI-56108
Bone Currettes
Fig 88,



Fig. 1
Hemingway

Hemingway
RI-56109
Bone Currettes
Fig 1,



Fig. 2
Hemingway

Hemingway
RI-56110
Bone Currettes
Fig 2,



Fig. 3
Hemingway

Hemingway
RI-56111
Bone Currettes
Fig 3,



Fig. 4
Hemingway

Hemingway
RI-56112
Bone Currettes
Fig 4,

BONE CURETTES



Fig. 85
Lucas

Lucas
RI-56113
Bone Curettes
Fig 85,



Fig. 86
Lucas

Lucas
RI-56114
Bone Curettes
Fig 86,



Fig. 87
Lucas

Lucas
RI-56115
Bone Curettes
Fig 87,



Fig. 88
Lucas

Lucas
RI-56116
Bone Curettes
Fig 88,

COTTON & DRESSING TWEEZERS



Cotton & Dressing Tweezers
RI-57101
Tooth Tweezers
130 mm, 5 1/8",



College Tweezer
RI-57102
Cotton & Dressing Tweezers
130 mm, 5 1/8",



College Tweezer Smooth Plan Handle
RI-57103
Cotton & Dressing Tweezers
150 mm, 6,



Meriam Tweezers
RI-57104
Cotton & Dressing Tweezers
150 mm, 6,



College Tweezer
RI-57105
Cotton & Dressing Tweezers
160 mm, 6,



Meriam Tweezers
RI-57106
Cotton & Dressing Tweezers
160 mm, 6,

COTTON & DRESSING TWEEZERS



Meriam Tweezers
RI-57107
Cotton & Dressing Tweezers
160 mm, 6,



College Tweezer
RI-57108
Cotton & Dressing Tweezers
150 mm, 6,



College Tweezer
RI-57109
Cotton & Dressing Tweezers
150 mm, 6,



Self Locking Tweezer Serr.
RI-57110
Cotton & Dressing Tweezers
150 mm, 6,



College Tweezer
RI-57111
Cotton & Dressing Tweezers
150 mm, 6,



College Tweezer
RI-57112
Cotton & Dressing Tweezers
150 mm, 6,

COTTON & DRESSING TWEEZERS



Cotton & Dressing Tweezers
RI-57119
Tooth Tweezers
150 mm, 6"



Self Locking Tweezer Smooth
RI-57120
Cotton & Dressing Tweezers
150 mm, 6"



Suture Forcep
RI-57121
Cotton & Dressing Tweezers
150 mm, 6"

COTTON & DRESSING TWEEZERS



Perry Tweezer
RI-57113
Cotton & Dressing Tweezers
130 mm,



RI-57114
Cotton & Dressing Tweezers
150 mm,6,



Flagg Tweezer Smooth
RI-57115
Cotton & Dressing Tweezers
150 mm,6,



Flagg Tweezer Serrated
RI-57116
Cotton & Dressing Tweezers
150 mm,6,



RI-57117
Cotton & Dressing Tweezers
150 mm,6,



Cotton & Dressing Tweezers
RI-57118
Tooth Tweezers
150 mm,6",

RUBBER DAM PUNCH & CLAMPS



Rubber Dam Punch Ivory
RI-58101
RubberDam Instruments
160 mm,6,



Anisworth
RI-58102
RubberDam Instruments
160 mm,6?,



Brewer
RI-58103
RubberDam Instruments
170 mm,6?,



Palmer
RI-58104
RubberDam Instruments
175 mm,7,

ORTHODONTIC PLIERS



BIRD BEAK PLIER
RI-59101
ORTHODONTIC PLIERS, ANGLE



CUTTING PLIER FOR ORTHODONTICS
RI-59102
ORTHODONTIC PLIERS NO.1



CUTTING PLIERS FOR ORTHODONTIC
RI-59103
ORTHODONTIC PLIERS NO.2



DE LA ROSA ORTHO PLIER
RI-59104
ORTHODONTIC GROOVED PLIERS, DE LA ROSA



DE LA ROSA ORTHO PLIERS
RI-59105
ORTHODONTIC NON GROOVED PLIERS,
DE LA ROSA



DISTAL END CUTTER
RI-59106
DISTAL END CUTTER

ORTHODONTIC PLIERS



DISTAL END CUTTER
RI-59107 ITC



HARD WIRE CUTTER TC
RI-59108 3TC



LIGHT WIRE CUTTER
RI-59109
MICROMINIATURE WIRE CUTTER



LIGHT WIRE CUTTER
RI-59110 ITC



MC KELLOPS PLIERS FOR ORTHODON
RI-59111
ORTHODONTIC PLIERS, MC KELLOPS



MICRO DISTAL END CUTTER
RI-59112
MICRO DISTAL WIRE CUTTER

ORTHODONTIC PLIERS



NANCE PLIERS FOR ORTHODONTICS
RI-59113
ORTHODONTIC PLIERS NANCE



ORTHODONTIC PLIERS
RI-59114
ORTHODONTIC PLIERS TO FORM
LINGUAL ARCHES

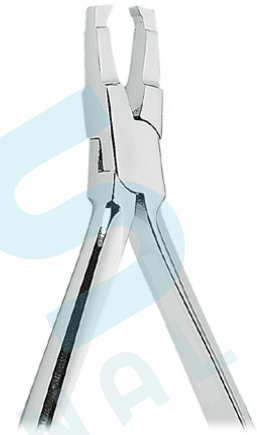

ORTHODONTIC PLIER
RI-59115
ORTHODONTIC PLIERS TO REMOVE
BRACKETS



ORTHODONTIC PLIER
RI-59116
ORTHODONTIC ATTACHMENT REMOVER
PLIERS



ORTHODONTIC PLIERS
RI-59117
ORTHODONTIC ATTACHMENTS
REMOVER PLIERS



ORTHODONTIC PLIERS
RI-59118
ORTHODONTIC DIRECT BONDING PLIERS

ORTHODONTIC PLIERS



PLIERS FOR ORTHODONTIC CURVED
RI-59119
ORTHODONTIC PLIERS HOW NO.2
CURVED



PLIERS FOR ORTHODONTICS
RI-59120
ORTHODONTIC PLIERS



PLIERS FOR ORTHODONTICS
RI-59121
ORTHODONTIC PLIERS NO.2



PLIERS FOR ORTHODONTICS
RI-59122
ORTHODONTIC PLIERS WITH SMOOTH
BEAKS



PLIERS FOR ORTHODONTICS
RI-59123
ORTHODONTIC PLIERS NO.2



PLIERS FOR ORTHODONTICS
RI-59124
ORTHODONTIC CONTOURING PLIERS,
REYNOLDS

ORTHODONTIC PLIERS



PLIERS FOR ORTHODONTICS
RI-59125
ORTHODONTIC PLIERS, WALDSACHS



PLIERS FOR ORTHODONTICS
RI-59126
ORTHODONTIC PLIERS JOHNSON



PLIERS FOR ORTHODONTICS
RI-59127
ORTHODONTIC PLIERS, NANCE

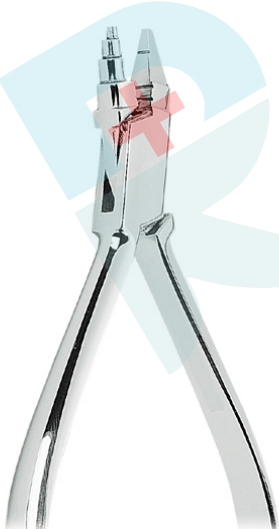

PLIERS FOR ORTHODONTICS
RI-59128
ORTHODONTIC PLIERS, YOUNG



PLIERS FOR ORTHODONTICS
RI-59129
ORTHODONTIC PLIERS



PLIERS FOR ORTHODONTICS
RI-59130
ORTHODONTIC PLIERS WITH ROUNDED
JAW

ORTHODONTIC PLIERS



PLIERS FOR ORTHODONTICS
RI-59137
ORTHODONTIC PLIERS



PLIERS FOR ORTHODONTICS
RI-59138
ORTHODONTIC PLIERS, ANGLE NO.1

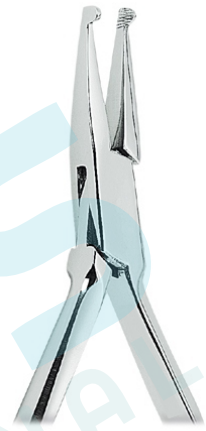

PLIERS FOR ORTHODONTICS STR.
RI-59139
ORTHODONTIC PLIERS HOW NO.1
STRAIGHT



POSTERIOR BAND REMOVER
RI-59140
ORTHODONTIC BAND REMOVER PLIERS



POSTERIOR BAND REMOVER
RI-59141
ORTHODONTIC BAND REMOVER PLIERS



UNIVERSAL PLIERS FOR ORTHODON.
RI-59142
UNIVERSAL ORTHODONTIC PLIERS

ORTHODONTIC PLIERS



PLIERS FOR ORTHODONTICS
RI-59131
ORTHODONTIC PLIERS, ANGLE



PLIERS FOR ORTHODONTICS
RI-59132
ORTHODONTIC PLIERS, ADAMS

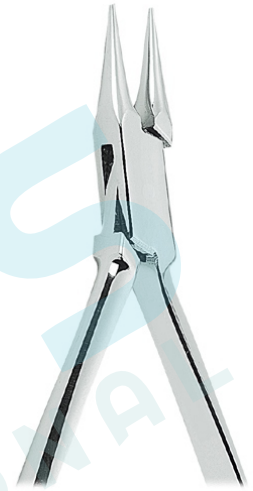

PLIERS FOR ORTHODONTICS
RI-59133
ORTHODONTIC PLIERS WITH ROUND
NOSE



PLIERS FOR ORTHODONTICS
RI-59134
ORTHODONTIC PLIERS, ADERER



PLIERS FOR ORTHODONTICS
RI-59135
ORTHODONTIC PLIERS ADERER



PLIERS FOR ORTHODONTICS
RI-59136
ORTHODONTIC PLIERS, TWEED

ORTHODONTIC PLIERS



UNIVERSAL ORTHO PLIERS

RI-59143

UNIVERSAL BENDING ORTHODONTIC
PLIERS



ROUND AND CONCAVE PLIERS

RI-59144

ORTHODONTIC PLIERS, ROUND AND
CONCAVE



TWEED ORTHO PLIER

RI-59145

ORTHODONTIC PLIERS, TWEED



TWEED ORTHO PLIERS

RI-59146

ORTHODONTIC PLIERS, TWEED



TWEED ORTHO PLIERS

RI-59147

ORTHODONTIC LOOP FORMING
PLIERS, TWEED



WEINGART ORTHO PLIERS

RI-59148

ORTHODONTIC UNIVERSAL PLIERS,
WEINGART

ORTHODONTIC PLIERS



WIRE CUTTER

RI-59151

WIRE CUTTER FOR ANY SIZE LIGATURE
WIRES



WIRE CUTTER

RI-59152 ITC



HARD WIRE CUTTER TC

RI-59153TC

NEEDLE HOLDERS



CrileMurray
RI-60101
Needle Holders
130 mm,5,



MayoHegar
RI-60102
Needle Holders
145 mm,5,



CrileMurray
RI-60103
Needle Holders
150 mm,6,



MayoHegar
RI-60104
Needle Holders
150 mm,6,



MayoHegar
RI-60105
Needle Holders
180 mm,7,



MayoHegar
RI-60106
Needle Holders
200 mm,8,

NEEDLE HOLDERS



OlsenHegar
RI-60107
Needle Holders
140 mm,5,

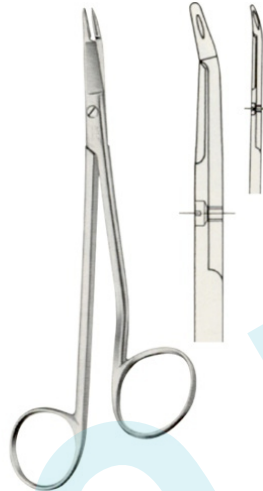

Gillies
RI-60108
Needle Holders
150 mm,6,



Boynton
RI-60109
Needle Holders
125 mm,5,



Mathieu
RI-60110
Needle Holders
170 mm,6,



Mathieu
RI-60111
Needle Holders
200 mm,8,



Crile
RI-60112
Needle Holders
150 mm,6,

NEEDLE HOLDERS



Toennis
RI-60113
Needle Holders
180 mm,7,



MayoHegar
RI-60114
Needle Holders
165 mm,6,



MayoHegar
RI-60115
Needle Holders
210 mm,8,



MayoHegar
RI-60116
Needle Holders
165 mm,6,



MayoHegar
RI-60117
Needle Holders
210 mm,8,



Debakey
RI-60118
Needle Holders
150 mm,6,

NEEDLE HOLDERS



Debakey
RI-60119
Needle Holders
180 mm,7,



Ryder
RI-60120
Needle Holders
135 mm,5,



Ryder
RI-75121
Needle Holders
155 mm,6,

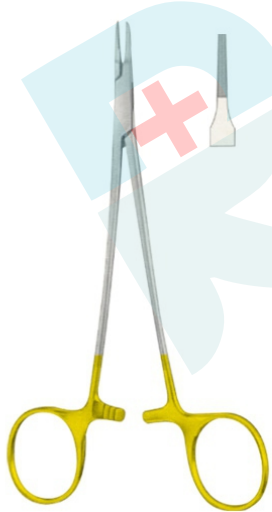

Ryder 7 CARBNSERT Jaws
RI-60122
Needle Holders
175 mm,7,



Bozemann 5
RI-60123
Needle Holders
135 mm,5,



OlsenHegar CARBNSERT Jaws
RI-60124
Needle Holders
125 mm,5,

NEEDLE HOLDERS



OlsenHegar CARBNSERT Jaws
RI-60125
Needle Holders
165 mm,6,



OlsenHegar CARBNSERT Jaws
RI-60126
Needle Holders
160 mm,6,

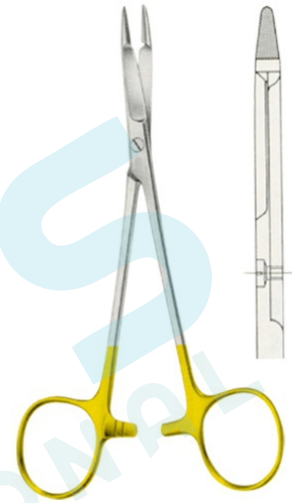

OlsenHegar CARBNSERT Jaws
RI-60127
Needle Holders
145 mm,5,



Needle Holders
RI-60128
Needle Holders
185 mm,7",



Needle Holders
RI-60129
Needle Holders
180 mm,7",



Ryder 8 CARBNSERT Jaws
RI-60130
Needle Holders
200 mm,8,

NEEDLE HOLDERS



Needle Holders
RI-60131
Needle Holders
200 mm, 8",



Mathieu 5
RI-60132
Needle Holders
140 mm, 5,



Mathieu 6
RI-60133
Needle Holders
170 mm, 6,



Mathieu 8
RI-60134
Needle Holders
200 mm, 8,



Mathieu 5
RI-60135
Needle Holders
140 mm, 5,



Mathieu 6
RI-60136
Needle Holders
170 mm, 6,

NEEDLE HOLDERS



Mathieu 8
RI-60137
Needle Holders
200 mm,8,



Mathieu 7
RI-60138
Needle Holders
195 mm,7,



Mathieu CARBNSERT Jaws
RI-60139
Needle Holders
205 mm,8,

GUM SCISSORS



SHORTBENT Stitch Scissors
RI-61107

Gum Scissors
Curved delicate
3 1/2" (8.9 cm),



LITTAUER JR. Stitch Scissors
RI-61108

Gum Scissors
4 1/2" (11.4 cm),



NORTHBENT Stitch Scissors
RI-61109

Gum Scissors
Curved light pattern
4 3/4" (12.1 cm),



LITTAUER Stitch Scissors
RI-61110

Gum Scissors
Standard pattern
5 1/2" (14 cm),



LONG Oral Surgery Stitch Scissors
RI-61111

Gum Scissors
6" (15.2 cm),



MILTEX Stitch Scissors
RI-61112

Gum Scissors
Angled delicate
4 1/2" (11.4 cm),

GUM SCISSORS



LISTER Bandage Scissors
RI-61101

GUM Scissors
Extra fine
4 1/2" (11.4 cm),



LISTER Bandage Scissors
RI-61102

Gum Scissors
Extra fine
5 1/2" (14 cm),



LISTER Bandage Scissors
RI-61103

Gum Scissors
Extra fine
7 1/4" (18.4 cm),



KNOWLES Bandage Scissors
RI-61104

Gum Scissors
Straight
5 1/2" (14 cm),



HEATH Suture Scissors
RI-61105

Gum Scissors
Serrated blade
6 1/8" (15.6 cm),



SPENCER Stitch Scissors
RI-61106

Gum Scissors
Delicate
3 1/2" (8.9 cm),

GUM SCISSORS



MILTEX Wire Cutting Scissors

RI-61119

Gum Scissors

Angled to side, one serrated blade, CarbN

Sert inserts

43/4" (12.1 cm),



Standard Pattern Operating Scissors

RI-61120

Gum Scissors

Straight sharpsharp points

41/2" (11.4 cm),



Standard Pattern Operating Scissors

RI-61121

Gum Scissors

Straight sharpsharp points

51/2" (14 cm),



Standard Pattern Operating Scissors

RI-61122

Gum Scissors

Straight sharpblunt points

41/2" (11.4 cm),



Standard Pattern Operating Scissors

RI-61123

Gum Scissors

Straight sharpblunt points

51/2" (14 cm),



Standard Pattern Operating Scissors

RI-61124

Gum Scissors

Straight sharpblunt points

51/2" (14 cm),

GUM SCISSORS



REEH Stitch Scissors

RI-61113

Gum Scissors
Sharp tips small hook on 1 blade ribbon type
33/4" (9.5 cm),



MILTEX Stitch Scissors

RI-61114

Gum Scissors
Curved sharp pointed tips ribbon type
37/8" (9.8 cm),

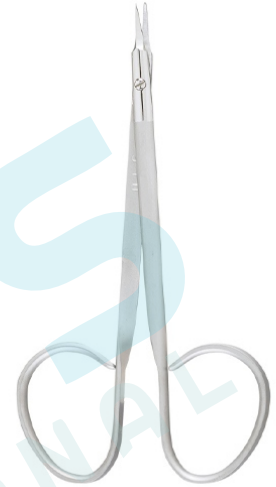

MILTEX Stitch Scissors

RI-61115

Gum Scissors
Curved sharp pointed tips ribbon type
41/2" (11.4 cm),



VANTAGE Crown Scissors

RI-61116

Gum Scissors
Collar curved
4" (10.2 cm),



VANTAGE Collar

RI-61117

Gum Scissors
Crown Scissors straight
4" (10.2 cm),



MILTEX Wire Cutting Scissors

RI-61118

Gum Scissors
Angled to side one serrated blade
43/4" (12.1 cm),

GUM SCISSORS



Standard Pattern Operating Scissors
RI-61125

Gum Scissors
Curved sharp/sharp points
4 1/2" (11.4 cm),



Standard Pattern Operating Scissors
RI-61126

Gum Scissors
Curved sharp/sharp points
5 1/2" (14 cm),



Standard Pattern Operating Scissors
RI-61127

Gum Scissors
Curved
4 1/2,



Standard Pattern Operating Scissors
RI-61128

Gum Scissors
Curved, sharp/blunt points
5 1/2" (14 cm),



MAYO Dissecting Scissors
RI-61129

Gum Scissors
Straight, standard beveled blades
5 1/2" (14 cm),



MAYO Dissecting Scissors
RI-61130

Gum Scissors
Straight, standard beveled blades
5 1/2" (14 cm),

GUM SCISSORS



Delicate Pattern METZENBAUM Scissors
RI-61137

Gum Scissors
Curved, blunt points
5 1/2" (14 cm),



Delicate Pattern METZENBAUM Scissors
RI-61138

Gum Scissors
Curved, sharp points
5 1/2" (14 cm),

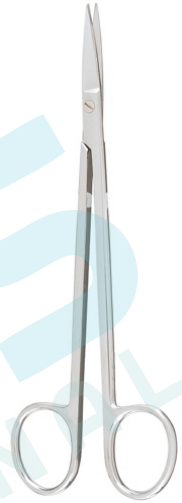

KELLY Scissors
RI-61139

Gum Scissors
Straight, sharp points
6 1/4" (15.9 cm),



KELLY Scissors
RI-61140
Gum Scissors
Curved, sharp points
6 1/4" (15.9 cm),



KELLY Scissors
RI-61141
Gum Scissors
Sharp points, angled on side
6 1/4" (15.9 cm),



KAYE Blepharoplasty and Dissecting
Scissors
RI-61142
Gum Scissors
One serrated blade, ribbon type
4 1/4" (10.8 cm),

GUM SCISSORS



MAYO Dissecting Scissors
RI-61131
Gum Scissors
Curved, standard beveled blades
5 1/2" (14 cm),



MAYO Dissecting Scissors
RI-61132
Gum Scissors
Curved, standard beveled blades
5 1/2" (14 cm),



Delicate Pattern METZENBAUM Scissors
RI-61133
Gum Scissors
Straight, blunt points
5 1/2" (14 cm),



Delicate Pattern METZENBAUM Scissors
RI-61134
Gum Scissors
Straight, sharp points
5 1/2" (14 cm),



Standard Pattern METZENBAUM Scissors
RI-61135
Gum Scissors
Curved, blunt points
5 1/2" (14 cm),



Standard Pattern METZENBAUM Scissors
RI-61136
Gum Scissors
Curved, blunt points
5 1/2" (14 cm),

GUM SCISSORS



DEAN Dissecting Scissors

RI-61143

Gum Scissors

Blades angled on flat, one serrated blade
63/4" (17.1 cm),



KAYE Dissecting Scissors

RI-61144

Gum Scissors

Curved, one serrated blade
417/32" (11.5 cm),



WAGNER Plastic Surgery Scissors

RI-61145

Gum Scissors

Straight, sharpsharp points, serrated blade
43/4" (12.1 cm),

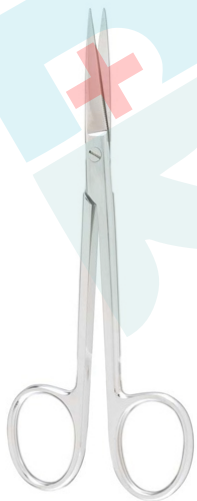

WAGNER Plastic Surgery Scissors

RI-61146

Gum Scissors

Straight, sharpsharp points, serrated blade
43/4" (12.1 cm),



WAGNER Plastic Surgery Scissors

RI-61147

Gum Scissors

Straight, sharpblunt points
43/4" (12.1 cm),



WAGNER Plastic Surgery Scissors

RI-61148

Gum Scissors

Straight, sharpblunt points, serrated blade
43/4" (12.1 cm),

GUM SCISSORS



WAGNER Plastic Surgery Scissors
RI-61149
Gum Scissors
Straight, bluntblunt points
43/4" (12.1 cm),



WAGNER Plastic Surgery Scissors
RI-61150
Gum Scissors
Straight, bluntblunt points, serrated blade
43/4" (12.1 cm),

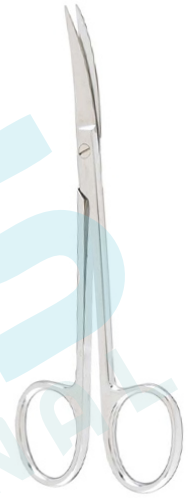

WAGNER Plastic Surgery Scissors
RI-61151
Gum Scissors
Curved, sharpsharp points
43/4" (12.1 cm),



WAGNER Plastic Surgery Scissors
RI-61152
Gum Scissors
Curved, sharpsharp points, serrated blade
43/4" (12.1 cm),



WAGNER Plastic Surgery Scissors
RI-61153
Gum Scissors
Curved, sharpblunt points
43/4" (12.1 cm),



WAGNER Plastic Surgery Scissors
RI-61154
Gum Scissors
Curved, sharpblunt points, serrated blade
43/4" (12.1 cm),

GUM SCISSORS



WAGNER Plastic Surgery Scissors
RI-61155
Gum Scissors
Curved, bluntblunt points
43/4" (12.1 cm),



WAGNER Plastic Surgery Scissors
RI-61156
Gum Scissors
Curved, bluntblunt points, serrated blade
43/4" (12.1 cm),

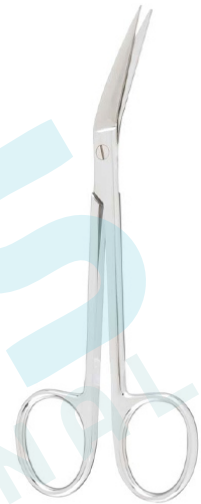

WAGNER Plastic Surgery Scissors
RI-61157
Gum Scissors
Straight, sharpsharp points
43/4" (12.1 cm),



WAGNER Plastic Surgery Scissors
RI-61158
Gum Scissors
Straight, sharpsharp point, serrated blade
43/4" (12.1 cm),



Delicate Pattern METZENBAUM Scissors
RI-61159
Gum Scissors
Curved
5" (12.7 cm),



Iris Scissors
RI-61160
Gum Scissors
Straight
4" (10.2 cm),

GUM SCISSORS



BROPHY Scissors
RI-61167
Gum Scissors
Straight, sharp points
5 1/2" (14 cm),



BROPHY Scissors
RI-61168
Gum Scissors
Curved, sharp points
5 1/2" (14 cm),



GOLDMANFOX Scissors
RI-61169
Gum Scissors
Curved fine tips, one serrated blade
4" (10.2 cm),



GOLDMANFOX Scissors
RI-61170
Gum Scissors
Curved fine tips, one serrated blade
5 1/2" (14 cm),



KELLY Scissors
RI-61171
Gum Scissors
Sharp points, straight, one serrated blade
6 1/4" (15.9 cm),



KELLY Scissors
RI-61172
Gum Scissors
Sharp points, curved, one serrated blade
6 1/4" (15.9 cm),

GUM SCISSORS



Iris Scissors
RI-61161
Gum Scissors & Curved
4" (10.2 cm), 4.5" (11.5 cm),



Iris Scissors
RI-61162
Gum Scissors
Straight
4 1/2" (11.4 cm),



Iris Scissors
RI-61163
Gum Scissors
Straight
4 1/2" (11.4 cm),



Iris Scissors
RI-61164
Gum Scissors
Curved
4 1/2" (11.4 cm),



Iris Scissors
RI-61165
Gum Scissors
Curved
4 1/2" (11.4 cm),



Iris Scissors
RI-61166
Gum Scissors
Angled on side
4 1/2" (11.4 cm),

GUM SCISSORS



KELLY Scissors
RI-61173

Gum Scissors
Sharp points, angular, one serrated blade
6 1/4" (15.9 cm),



Iris Operating Scissors
RI-61174

Gum Scissors
Curved sideways
4 1/2" (11.4 cm),

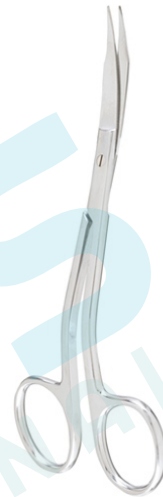

GOLDMANFOX Scissors
RI-61175

Gum Scissors
Curved, one serrated blade, angled shank
4 1/2" (11.4 cm),



LA GRANGE Scissors
RI-61176

Gum Scissors
Curved, one serrated blade, angled shank
4 1/4" (10.8 cm),



BROPHY Operating Scissors
RI-61177

Gum Scissors
Curved, sharp/sharp, with one serrated blade
5 1/2" (14 cm),



LOCKLIN Operating Scissors
RI-61178

Gum Scissors
Angled on side 25 degrees, one serrated blade
6 1/4" (15.9 cm),

GUM SCISSORS



LOCKLIN Operating Scissors
RI-61179

Gum Scissors

Curved shank, angled on side 25 degrees,
one serrated blade
6 1/4" (15.9 cm),



MILTEX SuperCut GOLDMANFOX Gum Scissors
RI-61180

Gum Scissors
Curved

4 1/2" (11.4 cm),



HEATH Suture Scissors
RI-61181

Gum Scissors
Serrated blade
6 1/8" (15.6 cm),



Iris Scissors

RI-61182

Gum Scissors

Straight, with 20 mm blades, delicate
3 1/2" (8.9 cm),



Iris Scissors

RI-61183

Gum Scissors

Curved, with 20 mm blades, delicate
3 1/2" (8.9 cm),



NOYES (ROSS) Iris Scissors

RI-61184

Gum Scissors

Curved, sharp/sharp points
4 1/2" (11.4 cm),

GUM SCISSORS



CASTROVIEJO Corneal Scissors
RI-61185

Gum Scissors
Curved, sharp points
33/4" (9.5 cm),



QUIMBY Gum Scissors

RI-61186

Gum Scissors
Strongly curved and pointed, smooth blades
15 mm
4" (10.2 cm),



JOSEPH Scissors

RI-61187

Gum Scissors
Straight
53/4" (14.6 cm),



JOSEPH Scissors

RI-61188

Gum Scissors
Curved
53/4" (14.6 cm),

AMALGAM INSTRUMENTS

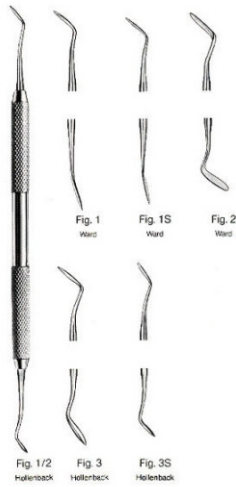

Hollenback
RI-62101
Amalgam Instruments
Fig 1/2,



Hollenback
RI-62107
Amalgam Instruments
Fig 1/2,



Mortonson 1
RI-62113
Amalgam Instruments
Fig 1,



RI-62114
Amalgam Instruments
Fig 2,



RI-62115
Amalgam Instruments
Fig 3,



RI-62116
Amalgam Instruments
Fig 4,

AMALGAM INSTRUMENTS



Fig SHO-A

RI-62117
Amalgam Instruments
Fig SHO-A,



Fig 3-SHO

RI-62118
Amalgam Instruments
Fig 3-SHO,



Fig 104

RI-62119
Amalgam Instruments
Fig 104,



Fig. 8

RI-62120
Amalgam Instruments
Fig 8,



Fig. 1

RI-62121
Amalgam Instruments
Fig 1,



Fig. 2

RI-62122
Amalgam Instruments
Fig 2,

AMALGAM INSTRUMENTS



Fig 3

RI-62123
Amalgam Instruments
Fig 3,



Fig 4

RI-62124
Amalgam Instruments
Fig 4,



Fig SHO-A

RI-62125
Amalgam Instruments
Fig SHO-A,



Fig 3-SHO

RI-62126
Amalgam Instruments
Fig 3SHO,



Fig 104

RI-62127
Amalgam Instruments
Fig 104,



Fig 8

RI-62128
Amalgam Instruments
Fig 8,

AMALGAM INSTRUMENTS



RI-62129
Amalgam Instruments
Fig 1,



RI-62130
Amalgam Instruments
Fig 2,



RI-62131
Amalgam Instruments
Fig 3,



RI-62132
Amalgam Instruments
Fig 4,



RI-62133
Amalgam Instruments
Fig 1,



RI-62134
Amalgam Instruments
Fig 2,

AMALGAM INSTRUMENTS



Amalgam Instruments
RI-62145
Amalgam Pistolen
135 mm,



Amalgam Instruments
RI-62146
Amalgam Pistolen
145 mm,



Amalgam Carrier
RI-62147
?
Fig. 1, Fig. 2, Fig. 3,



Amalgam Carrier
RI-62148
?
Fig. 1, Fig. 2, Fig. 3,



Amalgam Carrier
RI-62149
?
Fig. 1, Fig. 2, Fig. 3,

AMALGAM INSTRUMENTS



RI-62135
Amalgam Instruments
Fig 3,



RI-62136
Amalgam Instruments
Fig 4,



ToffemireUniversal
RI-62137
Amalgam Instruments
Ivory Fig 8, 5 mm, 6 mm, 7 mm,

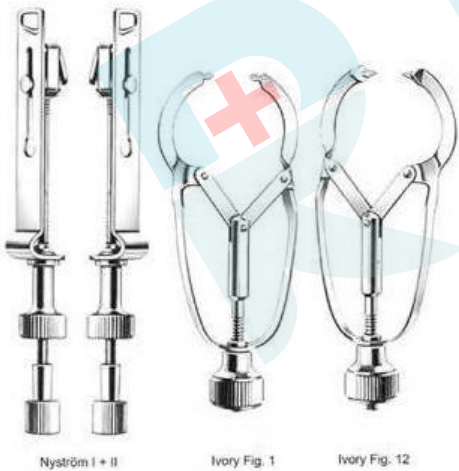

RI-62142
Amalgam Instruments
Ivory Fig 1, Ivory Fig 2,



Amalgam Instruments
RI-62143
Amalgam Pistolen
210 mm,



Amalgam Instruments
RI-62144
Amalgam Pistolen
185 mm,

MOUTH GAGS & RETRACTOR



Heister
RI-63141
Mouth Gags,
130 mm, 5 1/8,



MOLT PEDIATRIC
RI-63142
Mouth Gags,
100 mm, 4,



MOLT CHILD
RI-63143
Mouth Gags,
120 mm, 4,



MOLT ADULT
RI-63144
Mouth Gags,
140 mm, 5,



FERGUSONACKLAND
RI-63145
Mouth Gags,
145 mm, 5,



DENHART
RI-63146
Mouth Gags,
125 mm, 5,

MOUTH GAGS & RETRACTOR



ROSERKONIG
RI-63147
Mouth Gags,
160 mm, 6 1/4,



ROSERKONIG
RI-63148
Mouth Gags,
185 mm, 7,

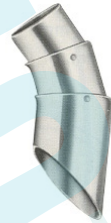

LANGENBECK
RI-63149
Finger Protectors
185 mm, 7,

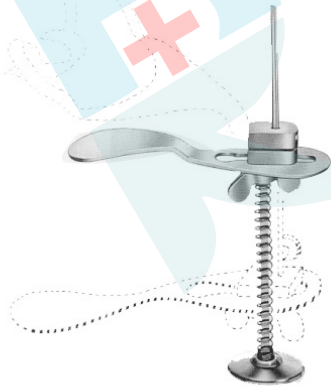

RI-63150
Tongue Depressor and Cheek Retractors

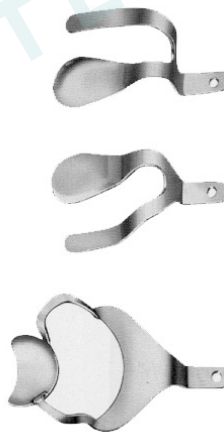

Retractor
RI-63151
Mouth Gags,



HARTMANN
RI-63152
Retractors
145 mm, 5,

MOUTH GAGS & RETRACTOR



Retractor
RI-63153
Mouth Gags,
140 mm,5,



SCHMID
RI-63154
Mouth Gags,
140 mm,5,



Retractor
RI-63155
Mouth Props
140 mm,5?,

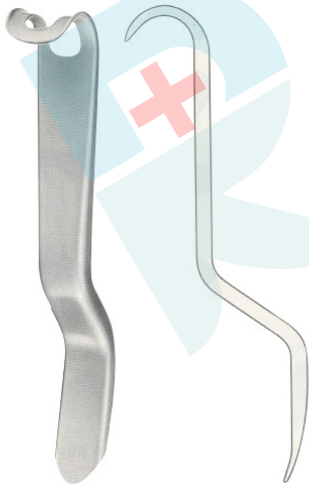

Retractor
RI-63156
Retractors
160 mm,6?,



VESTIBULUM RETRACTOR
RI-63157
Retractors
140 mm,5,



STERNBERG
RI-63158
Retractors
120 mm,4,

MOUTH GAGS & RETRACTOR



ROUX
RI-63159
Retractors
19x22 mm, 23x30 mm,



ROUX
RI-63160
Retractors
25x26 mm, 28x38 mm,



ROUX
RI-63161
Retractors
28x29 mm, 33x45 mm,



MIDDELDORPF
RI-63162
Retractors
15x15, 200 mm, 8,



MIDDELDORPF
RI-63163
Retractors
22x22 mm, 210 mm, 8,



MIDDELDORPF
RI-63164
Cheek Retractors
26x30 mm, 230 mm, 9,

MOUTH GAGS & RETRACTOR



Retractor
RI-63171
Retractors
165 mm,6?"



Retractor
RI-63172
Retractors
165 mm,6?"



Retractor
RI-63173
Retractors
165 mm,6?"



Retractor
RI-63174
Retractors
160 mm,6?"



Retractor
RI-63175
Retractors
160 mm,6?"



LANGENBECKGREEN
RI-63176
Retractors
160 mm,16x6 mm,

MOUTH GAGS & RETRACTOR



Gauze Case
RI-63165
Gauze Case
26x30 mm,230 mm,9,



Retractor
RI-63166
Retractors
165 mm,6?,"



Retractor
RI-63167
Retractors
165 mm,6?,"



Retractor
RI-63168
Retractors
165 mm,6?,"



Retractor
RI-63169
Retractors
165 mm,6?,"

PERIODONTIA INSTRUMENTS



Fig. 79
109/185
Kirkland

Kirkland

RI-64101
Periodontia Instruments
Fig 1/2,



Fig. 1/2
Orban

Orban

RI-64102
Periodontia Instruments
Fig 1/2,



Fig. 1/2
109/ 90
Kirkland

Kirkland

RI-64103
Periodontia Instruments
Fig 1/2,



Fig. 1/2
Orban

Orban

RI-64104
Periodontia Instruments
Fig 1/2,



Fig. 7
Goldman-Fox

GoldmanFox

RI-64105
Periodontia Instruments
Fig 7,



Fig. 8
Goldman-Fox

GoldmanFox

RI-64106
Periodontia Instruments
Fig 8,

PERIODONTIA INSTRUMENTS



Fig. 9
Goldman-Fox

GoldmanFox
RI-64107
Periodontia Instruments
Fig 9,



Fig 11
Goldman-Fox

GoldmanFox
RI-64108
Periodontia Instruments
Fig 11,



Fig. 3/4
Buck

Buck
RI-64109
Periodontia Instruments
Fig 3/4,



Fig. 5/6
Buck

Buck
RI-64110
Periodontia Instruments
Fig 5/6,



Fig. 7
Goldman-Fox

GoldmanFox
RI-64111
Periodontia Instruments
Fig 7,



Fig. 8
Goldman-Fox

GoldmanFox
RI-64112
Periodontia Instruments
Fig 8,

PERIODONTIA INSTRUMENTS



Fig 9
Goldman Fox

GoldmanFox
RI-64113
Periodontia Instruments
Fig 9,



Fig 11
Goldman Fox

GoldmanFox
RI-64114
Periodontia Instruments
Fig 11,



Fig. 3/4
Buck

Buck
RI-64115
Periodontia Instruments
Fig 3/4,



Fig. 5/6
Buck

Buck
RI-64116
Periodontia Instruments
Fig 5/6,



Fig. 1/2
Sanders

Sanders
RI-64117
Periodontia Instruments
Fig 1/2,



Fig. 4/5
Sanders

Sanders
RI-64118
Periodontia Instruments
Fig 4/5,

PERIODONTIA INSTRUMENTS



Fig. 19/20

OCHSENBEIN CHISEL NO 4
RI-64119
Periodontia Instruments
Fig 19/20,



Fig. 5/0

CraneKaplan
RI-64120
Periodontia Instruments
Fig CK3,



Fig. 1/2

Sanders
RI-64121
Periodontia Instruments
Fig 1/2,



Fig. 4/5

Sanders
RI-64122
Periodontia Instruments
Fig 4/5,



Fig. 19/20

OCHSENBEIN CHISEL NO 4
RI-64123
Periodontal Instruments
Fig 19/20,



Fig. CK3

CraneKaplan
RI-64124
Periodontia Instruments
Fig CK3,

PERIODONTIA INSTRUMENTS



Fig. HU 1/2
Curette

Curette

RI-64125
Periodontia Instruments
Fig HU 1/2,



Fig. 2R/2L
Columbia

Columbia

RI-64126
Periodontia Instruments
Fig 2R/2L,



Fig. 4R/4L
Columbia

Columbia

RI-64127
Periodontia Instruments
Fig 4R/4L,



Fig. 13/14
Columbia

Columbia

RI-64128
Periodontia Instruments
Fig 13/14,



Fig. 411/412

RI-64129
Periodontia Instruments
Fig 411/412,



Fig. 413/414

RI-64130
Periodontia Instruments
Fig 413/414,

PERIODONTIA INSTRUMENTS



Zerling-Chiles

ZerlingChiles
RI-64131
Periodontia Instruments
Fig 413/414,



Fig. HU 1/2
Curette

Curette
RI-64132
Periodontia Instruments
Fig HU 1/2,



Fig. 2R/2L
Columbia

Columbia
RI-64133
Periodontia Instruments
Fig 2R/2L,



Fig. 4R/4L
Columbia

Columbia
RI-64134
Periodontia Instruments
Fig 4R/4L,



Fig. 13/14
Columbia

Columbia
RI-64135
Periodontia Instruments
Fig 13/14,



Fig. 1/2
Langer

Langer
RI-64136
Periodontia Instruments
Fig 1/2,

PERIODONTIA INSTRUMENTS



Fig. 3/4
Langer

Langer

RI-64143
Periodontia Instruments
Fig 3/4,



Fig. 1/2
Barnhart

Barnhart

RI-64144
Periodontia Instruments
Fig 1/2,



Fig. 5/6
Barnhart

Barnhart

RI-64145
Periodontia Instruments
Fig 5/6,



Fig ME-1
[10/11]

RI-64146

Periodontia Instruments
Fig ME1,



Fig. 3/4
Wheeler

RI-64147

Periodontia Instruments
Fig 3/4,



Fig. 1/2
Gracey

Gracey

RI-64148
Periodontia Instruments
Fig 1/2,

PERIODONTIA INSTRUMENTS



Fig. 3/4
Langer

Langer

RI-64137
Periodontia Instruments
Fig 3/4,



Fig. 1/2
Barnhart

Barnhart

RI-64138
Periodontia Instruments
Fig 1/2,



Fig. 5/6
Barnhart

Barnhart

RI-64139
Periodontia Instruments
Fig 5/6,



Fig. ME-1

RI-64140

Periodontia Instruments
Fig ME1,



Fig. 3/4
Pure (23/24)

RI-64141

Periodontia Instruments
Fig 3/4,



Fig. 1/2
Langer

Langer

RI-64142

Periodontia Instruments
Fig 1/2,

PERIODONTIA INSTRUMENTS



Gracey

RI-64155
Periodontia Instruments
Fig 1/2,



Gracey

RI-64156
Periodontia Instruments
Fig 3/4,



Gracey

RI-64157
Periodontia Instruments
Fig 5/6,



Gracey

RI-64158
Periodontia Instruments
Fig 7/8,



Gracey

RI-64159
Periodontia Instruments
Fig 9/10,



Gracey

RI-64160
Periodontia Instruments
Fig 11/12,

PERIODONTIA INSTRUMENTS



Gracey

RI-64149
Periodontia Instruments
Fig 3/4,



Gracey

RI-64150
Periodontia Instruments
Fig 5/6,



Gracey

RI-64151
Periodontia Instruments
Fig 7/8,



Gracey

RI-64152
Periodontia Instruments
Fig 9/10,



Gracey

RI-64153
Periodontia Instruments
Fig 11/12,



Gracey

RI-64154
Periodontia Instruments
Fig 13/14,

PERIODONTIA INSTRUMENTS



Fig 13/14
Gracey

Gracey

RI-64161
Periodontia Instruments
Fig 13/14,



Fig. 11/14
Gracey

Gracey

RI-64162
Periodontia Instruments
Fig 11/14,



Fig 12/13
Gracey

Gracey

RI-64163
Periodontia Instruments
Fig 12/13,



Fig. 1
Ce Marco

Ce Marco

RI-64164
Periodontia Instruments
Fig 1,



Fig. 2
De Marco

De Marco

RI-64165
Periodontia Instruments
Fig 2,



Fig. 13/14
Anterior

Anterior

RI-64166
Periodontia Instruments
Fig 13/14,

PERIODONTIA INSTRUMENTS



Fig. 17/18
Posterior

Posterior

RI-64167
Periodontia Instruments
Fig 17/18,



Fig. 11/14
Gracey

Gracey

RI-64168
Periodontia Instruments
Fig 11/14,



Fig. 12/13
Gracey

Gracey

RI-64169
Periodontia Instruments
Fig 12/13,



Fig. 1
De Marco

De Marco

RI-64170
Periodontia Instruments
Fig 1,



Fig 2
De Marco

De Marco

RI-64171
Periodontia Instruments
Fig 2,



Fig. 13/14
Anterior

Anterior

RI-64172
Periodontia Instruments
Fig 13/14,

PERIODONTIA INSTRUMENTS



Fig. 17/18
Posterior

Posierior
RI-64173
Periodontia Instruments
Fig 17/18,



Fig. 1
Goldman-Fox

GoldmanFox
RI-64174
Periodontia Instruments
Fig 1,



Fig. 2
Goldman-Fox

GoldmanFox
RI-64175
Periodontia Instruments
Fig 2,



Fig. 3
Goldman-Fox

GoldmanFox
RI-64176
Periodontia Instruments
Fig 3,



Fig. 4
Goldman-Fox

GoldmanFox
RI-64177
Periodontia Instruments
Fig 4,



Fig. 5
Goldman-Fox

GoldmanFox
RI-64178
Periodontia Instruments
Fig 5,

PERIODONTIA INSTRUMENTS



GoldmanFox
RI-64179
Periodontia Instruments
Fig 6,



GoldmanFox
RI-64180
Periodontia Instruments
Fig 21,



GoldmanFox
RI-64181
Periodontia Instruments
Fig 1,



GoldmanFox
RI-64182
Periodontia Instruments
Fig 2,



GoldmanFox
RI-64183
Periodontia Instruments
Fig 3,



GoldmanFox
RI-64184
Periodontia Instruments
Fig 4,

PERIODONTIA INSTRUMENTS



Fig. 5
Goldman-Fox

GoldmanFox
RI-64185
Periodontia Instruments
Fig 5,



Fig. 6
Goldman-Fox

GoldmanFox
RI-64186
Periodontia Instruments
Fig 6,



Fig. 21
Goldman-Fox

GoldmanFox
RI-64187
Periodontia Instruments
Fig 21,



Fig. 11/12
Mc Call

Mc Call
RI-64188
Periodontia Instruments
Fig 11/12,



Fig. 11A/12A
Mc Call

Mc Call
RI-64189
Periodontia Instruments
Fig 11A/12A,



Fig. 13/14
Mc Call

Mc Call
RI-64190
Periodontia Instruments
Fig 13/14,

PERIODONTIA INSTRUMENTS



Fig. 13S/14S
Mc Call

Mc Call

RI-64191
Periodontia Instruments
Fig 13S/14S,



Fig. 17S/18S
Mc Call

Mc Call

RI-64192
Periodontia Instruments
Fig 17S/18S,



Fig. 19/20
Mc Call

Mc Call

RI-64193
Periodontia Instruments
Fig 19/20,



Fig. 11/12
Mc Call

Mc Call

RI-64194
Periodontia Instruments
Fig 11/12,



Fig. 11A/12A
Mc Call

Mc Call

RI-64195
Periodontia Instruments
Fig 11A/12A,



Fig. 13/14
Mc Call

Mc Call

RI-64196
Periodontia Instruments
Fig 13/14,

PERIODONTIA INSTRUMENTS



Fig 13S/14S
Mc Call

Mc Call

RI-64197
Periodontia Instruments
Fig 13S/14S,



Fig. 17S/18S
Mc Call

Mc Call

RI-64198
Periodontia Instruments
Fig 17S/18S,



Fig. 19/20
Mc Call

Mc Call

RI-64199
Periodontia Instruments
Fig 19/20,



Fig. 2/3
Taylor

Taylor

RI-64200
Periodontia Instruments
Fig 2/3,



Fig. 204

RI-64201
Periodontia Instruments
Fig 204,



Fig. 204s

RI-64202
Periodontia Instruments
Fig 204s,

PERIODONTIA INSTRUMENTS



Fig 204S

RI-64209
Periodontia Instruments
Fig 204S,



Fig. 6
Crane-Kaplan

CraneKaplan
RI-64210
Periodontia Instruments
Fig 6,



Fig 7/8
Younger-Good

YoungerGood
RI-64211
Periodontia Instruments
Fig 7/8,



Fig. 3/7
Hirschfeld

Hirschfeld
RI-64212
Periodontia Instruments
Fig 3/7,



Fig. 30/33
Jaquette

Jaquette
RI-64213
Periodontia Instruments
Fig 30/33,



Fig. 31/32
Jaquette

Jaquette
RI-64214
Periodontia Instruments
Fig 31/32,

PERIODONTIA INSTRUMENTS



Fig. 204S

RI-64203
Periodontia Instruments
Fig 204S,



Fig. 6
Crane-Kaplan

CraneKaplan
RI-64204
Periodontia Instruments
Fig 6,



Fig. 7/8
Younger-Good

YoungerGood
RI-64205
Periodontia Instruments
Fig 7/8,



Fig. 2/3
Taylor

Taylor
RI-64206
Periodontia Instruments
Fig 2/3,



Fig. 204

RI-64207
Periodontia Instruments
Fig 204,



Fig. 204S

RI-64208
Periodontia Instruments
Fig 204S,

PERIODONTIA INSTRUMENTS



Fig. 31/32
Jaquette

Jaquette

RI-64215
Periodontia Instruments
Fig 31/32,



Fig. 37
Hirschfeld

Hirschfeld

RI-64216
Periodontia Instruments
Fig 37,



Fig. 30/33
Jaquette

Jaquette

RI-64217
Periodontia Instruments
Fig 30/33,



Fig. 31/32
Jaquette

Jaquette

RI-64218
Periodontia Instruments
Fig 31/32,



Fig. 34/35
Jaquette

Jaquette

RI-64219
Periodontia Instruments
Fig 34/35,



Fig. 37/38
Jaquette

Jaquette

RI-64220
Periodontia Instruments
Fig 37/38,

PERIODONTIA INSTRUMENTS



Fig. 1
Ochsenbein

Ochsenbein
RI-64221
Periodontia Instruments
Fig 1,



Fig. 2
Ochsenbein

Ochsenbein
RI-64222
Periodontia Instruments
Fig 2,



Fig. 1
Gardner

Gardner
RI-64223
Periodontia Instruments
Fig 1,



Fig. 2
Gardner

Gardner
RI-64224
Periodontia Instruments
Fig 2,



Fig. 5
Gardner

Gardner
RI-64225
Periodontia Instruments
Fig 5,



Fig. 5R
Gardner

Gardner
RI-64226
Periodontia Instruments
Fig 5R,

PERIODONTIA INSTRUMENTS



Fig 6
Gardner

Gardner
RI-64227
Periodontia Instruments
Fig 6,



Fig 1W
Wakef old

Wakef Old
RI-64228
Periodontia Instruments
Fig 1W,



Fig 2W
Wakef old

Wakef Old
RI-64229
Periodontia Instruments
Fig 2W,



Fig. 3
Buckley

Buckley
RI-64230
Periodontia Instruments
Fig 3,



Fig. M9
Molt

Molt
RI-64231
Periodontia Instruments
Fig M9,



Fig. PR3
Pricharo

Pricharo
RI-64232
Periodontia Instruments
Fig PR3,

PERIODONTIA INSTRUMENTS



Fig. 1
Hopkins

Hopkins

RI-64233
Periodontia Instruments
Fig 1,



Fig 2
Hopkins

Hopkins

RI-64234
Periodontia Instruments
Fig 2,

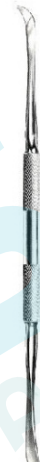

Fig. 15
Frerr

Frerr

RI-64235
Periodontia Instruments
Fig 15,



Fig. 16
Frerr

Frerr

RI-64236
Periodontia Instruments
Fig 16,



Fig. 3
Mead

Mead

RI-64237
Periodontia Instruments
Fig 3,



Fig. 23
Seldin retractor

Seldin retractor

RI-64238
Periodontia Instruments
Fig 23,

PERIODONTIA INSTRUMENTS



Williger
cm. 17

Williger

RI-64239
Periodontia Instruments
cm 17,



Williger
cm. 16

Williger

RI-64240
Periodontia Instruments
cm 16,



Williger
cm. 16

Williger

RI-64241
Periodontia Instruments
cm 16,



Williger
cm. 13

Williger

RI-64242
Periodontia Instruments
cm 13,



Fig 1S/2S
Explorer

Sugarman

RI-64243
Periodontia Instruments
Fig 1S/2S,



Fig. 3S/4S
Sugarman

Sugarman

RI-64244
Periodontia Instruments
Fig 3S/4S,

PERIODONTIA INSTRUMENTS



Fig. 1/2
TG Chisel

TG Chsel

RI-64245
Periodontia Instruments
Fig 1/2,



Fig. 1/2
TG Chisel

TG Chsel

RI-64246
Periodontia Instruments
Fig 1/2,



Fig. 1
TG Chisel

TG Chsel

RI-64247
Periodontia Instruments
Fig 1,



Fig. 2
TG Chisel

TG Chsel

RI-64248
Periodontia Instruments
Fig 2,



Fig. 1
(15K)
Kirkland

Kirkland

RI-64249
Periodontia Instruments
Fig 1,



Fig. 2
(16K)
Kirkland

Kirkland

RI-64250
Periodontia Instruments
Fig 2,

PERIODONTIA INSTRUMENTS



Fig. 1
Orban

Orban

RI-64251

Periodontia Instruments

Fig 1,

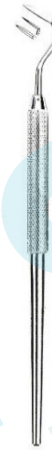

Fig. 2
Orban

Orban

RI-64252

Periodontia Instruments

Fig 2,

FILLING INSTRUMENTS

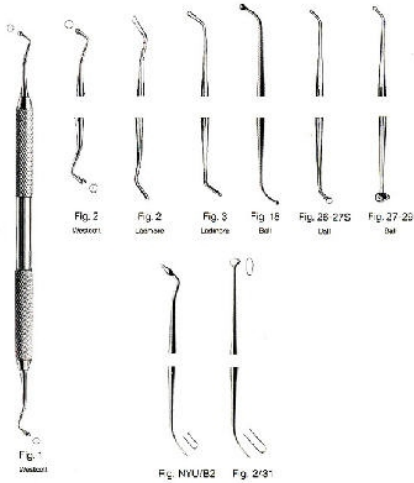

Westcott
RI-65101
Filling instruments
Fig 1,

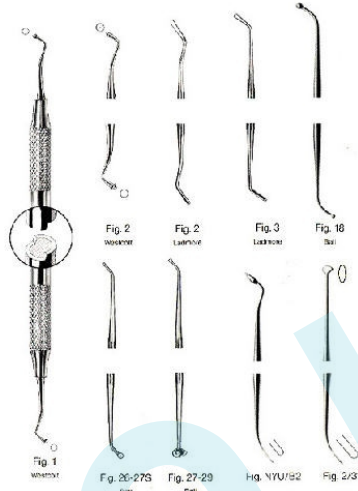

Westcott
RI-65110
Filling instruments
Fig 1,

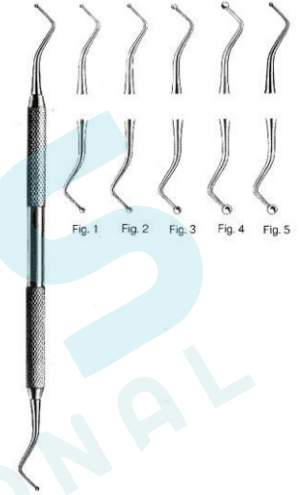

RI-65119
Filling instruments
Fig 1, Fig 2, Fig 3, Fig 4, Fig 5,

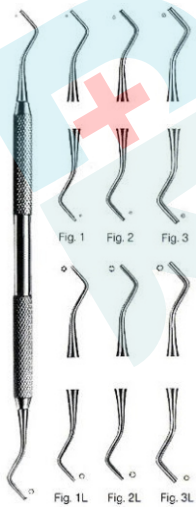

RI-65125
Filling instruments
Fig 1, Fig 2, Fig 3, Fig 1L, Fig 2L, Fig 3L,

CEMENT SPATULAS



RI-66101
No. 22 Cement Spatula



RI-66102
No. 24A Cement Spatula, Rigid



RI-66103
No. 24 Cement Spatula, Flexible



RI-66104
No. 313 Cement Spatula,



RI-66105
No. 5 Cement Spatula



RI-66106
No. 7 Cement Spatula

SINGLE/DOUBLE END EXPLORERS

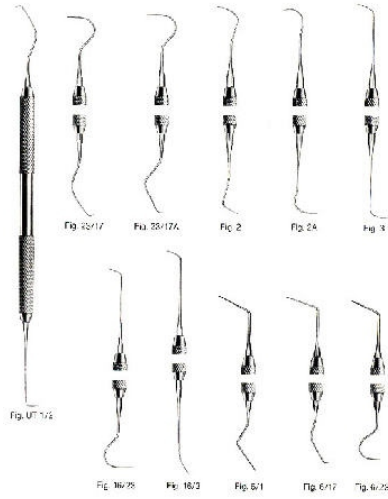

RI-67101
Single Ended/ Double Ended Explorers
Fig UT 1/2,

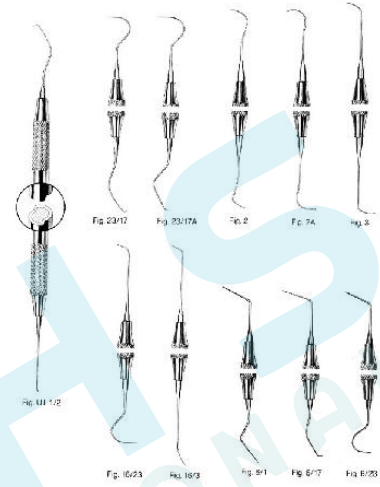

RI-67112
Single Ended/ Double Ended Explorers
Fig UT 1/2,

MIRROR HANDLES



SIMPLE STEM PLANE 4
RI-68113
MOUTH MIRROR
22 mm,



SIMPLE STEM PLANE 5
RI-68114
MOUTH MIRROR
24 mm,



SIMPLE STEM PLANE 4
RI-68115
MOUTH MIRROR
22 mm,



SIMPLE STEM PLANE 4
RI-68116
MOUTH MIRROR
22 mm,



SIMPLE STEM PLANE 4
RI-68117
MOUTH MIRROR
22 mm,



SECO / CONESOCKET
RI-68118
Mirror Handles
125 mm,5,

MIRROR HANDLES



OCTOGONAL CONE SOCKET
RI-68119
Mirror Handles
120 mm, 4,



MARTIN ERGO
RI-68120
Mirror Handles
135 mm, 5?,



Mirror Handles
RI-68121
Mirror Handles
135 mm, 5?,



Mirror Handles
RI-68122
Mirror Handle
135 mm, 5?,



Mirror Handles
RI-68123
Mirror Handles
135 mm, 5?,



Mirror Handles
RI-68124
Mirror Handles
135 mm, 5?,

MIRROR HANDLES



laryngeal Mirrors
RI-68128
MIRROR HANDLES
7 mm 30°, ø 4,



laryngeal Mirrors
RI-68129
MIRROR HANDLES
7 mm 30°, ø 4,



Cotton Wool Container
RI-68130
Cotton Wool Container
ø 50 mm,



Napkin Holder
RI-68131
Napkin Holder
ø 50 mm,



MIRROR HANDLE CONE SOCKET
RI-5372101
MIRROR HANDLES
14 cm /5,



MIRROR HANDLE CONE SOCKET
RI-5372102
MIRROR HANDLES
14 cm /5,

MIRROR HANDLES



MIRROR HANDLE CONE SOCKET
RI-5372301
MIRROR HANDLES
13 cm /5,



MIRROR HANDLE
RI-5372802
MIRROR HANDLES
12 cm /4,



MARTINGRIP
RI-5374602
12 cm /4?,



MIRROR HANDLE
RI-5375502
MIRROR HANDLES
14 cm /5 ø 11,



MIRROR HANDLE
RI-5375708
MIRROR HANDLES
14 cm /5,



MIRROR
RI-5370222

MIRROR HANDLES



MIRROR
RI-5370322



RHODIUM MIRROR
RI-5370410
MIRROR



RHODIUM MIRROR
RI-5370418
MIRROR



CONE SOCKET
RI-5370622
MIRROR



CONE SOCKET
RI-5370722
MIRROR



MICROMOUTH MIRROR
RI-5371003
Fig. 1,

ENDODONTIC INSTRUMENTS



Fig. 1
Spreader

Root Spreader fig 1
RI-69101
Endodontic Instruments
Fig. 1,



Fig. 2
Spreader

Root Spreader fig 2
RI-69102
Endodontic Instruments
Fig. 2,



Fig. 3
Spreader

Root Spreader Fig 3
RI-69103
Endodontic Instruments
Fig. 3,



Fig. 4
Spreader

Root Spreader Fig 4
RI-69104
Endodontic Instruments
Fig. 4,



Fig. 5
Spreader

Root Spreader Fig 5
RI-69105
Endodontic Instruments
Fig. 5,



Fig. 6
Spreader

Root Spreader Fig 6
RI-69106
Endodontic Instruments
Fig. 6,

MIRROR HANDLES



MICROMOUTH MIRROR
RI-5371005
Fig. 2,



RHODIUM MICRO MIRROR
RI-5371103
Fig.1 ? 3,0 mm,



HILGER
RI-5371500
18 cm /7,

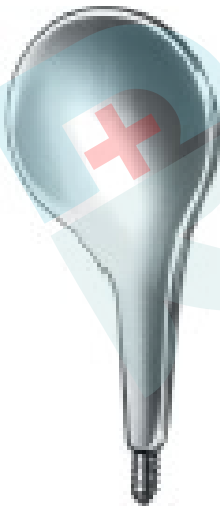

HILGER
RI-5371501
CHEEK RETRACTORS
Size 1,

ENDODONTIC INSTRUMENTS



Fig. 7
Spreader

Root Spreader Fig 7
RI-69107
Endodontic Instruments
Fig 7,



Fig. 1
Luks

Luks Fig 1
RI-69108
Endodontic Instruments
Fig 1,



Fig. 2

LUKS Fig 2
RI-69109
Endodontic Instruments
Fig 2,



Fig. 3

LUKS Fig 3
RI-69110
Endodontic Instruments
Fig 3,



Fig. 4

LUKS Fig 4
RI-69111
Endodontic Instruments
Fig 4,



Fig. 1

Vertical Condenser Fig 1
RI-69112
Endodontic Instruments
Fig 1,

ENDODONTIC INSTRUMENTS



Fig. 2

Vertical Condenser Fig 2
RI-69113
Endodontic Instruments
Fig 2,



Fig. 3

Vertical Condenser Fig 3
RI-69114
Endodontic Instruments
Fig 3,



Fig. 6/1

Root Canal Explorer Fig 6/1
RI-69116
Endodontic Instruments
Fig 6/1,



Fig. 6/17

Root Canal Explorer Fig 6/17
RI-69117
Endodontic Instruments
Fig 6/17,



Fig. 6/23

Root Canal Explorer Fig 6/23
RI-69118
Endodontic Instruments
Fig 6/23,



Fig. 31L

Root Canal Excavators Fig 31L
RI-69119
Endodontic Instruments
Fig 31L,

ENDODONTIC INSTRUMENTS



Fig. 32L

Root Canal Excavators Fig 32L
RI-69120
Endodontic Instruments
Fig 32L,



Fig. 33L

Root Canal Excavators Fig 33L
RI-69121
Endodontic Instruments
Fig 33L,



Fig. 6/1

Root Canal Explorers Fig 6/1
RI-69122
Endodontic Instruments
Fig 6/1,



Fig. 6/17

Root Canal Explorers Fig 6/17
RI-69123
Endodontic Instruments
Fig 6/17,



Fig. 6/23

Root Canal Explorers Fig 6/23
RI-69124
Endodontic Instruments
Fig 6/23,



Fig. 31L

Root Canal Excavators Fig 31L
RI-69125
Endodontic Instruments
Fig 31L,

ENDODONTIC INSTRUMENTS



Fig. 32L

Root Canal Excavators Fig 32L
RI-69126
Endodontic Instruments
Fig 32L,



Fig. 33L

Root Canal Excavators Fig 33L
RI-69127
Endodontic Instruments
Fig 33L,

SEPARATING SPATULAS



Heidemann
RI-70108
Separating Spatulas
Fig 8,



Heidemann
RI-70109
Separating Spatulas
Fig 9,



Heidemann
RI-70110
Separating Spatulas
Fig 1,



Heidemann
RI-70111
Separating Spatulas
Fig 2,



Heidemann
RI-70112
Separating Spatulas
Fig 3,

SEPARATING SPATULAS



Heidemann
RI-70101
Separating Spatulas
Fig 1,



Heidemann
RI-70102
Separating Spatulas
Fig 2,



Heidemann
RI-70104
Separating Spatulas
Fig 4,



Heidemann
RI-70105
Separating Spatulas
Fig 5,



Heidemann
RI-70106
Separating Spatulas
Fig 6,



Heidemann
RI-70107
Separating Spatulas
Fig 7,

EXCAVATORS



Fig. 0

Excavators Fig 0
RI-71101
Excavators
Fig 0,



Fig. 1

Excavators Fig 1
RI-71102
Excavators
Fig 1,



Fig. 2

Excavators Fig 2
RI-71103
Excavators
Fig 2,



Fig. 3

Excavators Fig 3
RI-71104
Excavators
Fig 3,



Fig. 4

Excavators Fig 4
RI-71105
Excavators
Fig 4,



Fig. 5

Excavators Fig 5
RI-71106
Excavators
Fig 5,

EXCAVATORS



Fig. 6

Excavators Fig 6
RI-71107
Excavators
Fig 6,



Fig. 0

Excavators Fig 0
RI-71108
Excavators
Fig 0,



Fig. 1

Excavators Fig 1
RI-71109
Excavators
Fig 1,



Fig. 2

Excavators Fig 2
RI-71110
Excavators
Fig 2,



Fig. 3

Excavators Fig 3
RI-71111
Excavators
Fig 3,



Fig. 4

Excavators Fig 4
RI-71112
Excavators
Fig 4,

EXCAVATORS



Fig. 5

Excavators Fig 5
RI-71113
Excavators
Fig 5,



Fig. 6

Excavators Fig 6
RI-71114
Excavators
Fig 6,



Fig 6

Excavators Fig 6
RI-71115
Excavators
Fig 6,



Fig. 14

Excavators Fig 14
RI-71116
Excavators
Fig 14,



Fig. 17

Excavators Fig 17
RI-71117
Excavators
Fig 17,



Fig. 17W

Excavators Fig 17W
RI-71118
Excavators
Fig 17W,

EXCAVATORS



Fig. 18

Excavators Fig 18
RI-71119
Excavators
Fig 18,



Fig. 18W

Oval spoon Fig 18W
RI-71120
Excavators
Fig 18W,



Fig. 19

Excavators Fig 19
RI-71121
Excavators
Fig 19,



Fig. 19W

Oval spoon Fig 19W
RI-71122
Excavators
Fig 19W,



Fig. 6

Excavators Fig 6
RI-71123
Excavators
Fig 6,



Fig. 14

Excavators Fig 14
RI-71124
Excavators
Fig 14,

EXCAVATORS



Fig. 17

Excavators Fig 17
RI-71125
Excavators
Fig 17,



Fig. 17W
Oval spoon

Oval spoon Fig 17W
RI-71126
Excavators
Fig 17W,



Fig. 18W
Oval spoon

Oval spoon 18W
RI-71127
Excavators
Fig 18W,



Fig. 19

Excavators Fig 19
RI-71129
Excavators
Fig 19,



Fig. 19W
Oval spoon

Oval spoon Fig 19W
RI-71130
Excavators
Fig 19W,



Fig. 38/39

Excavators Fig 38/39
RI-71131
Excavators
Fig 38/39,

EXCAVATORS



Fig. 63/64

Excavators Fig 63/64
RI-71133
Excavators
Fig 63/64,



Fig. 65/66

Excavators Fig 65/66
RI-71134
Excavators
Fig 65/66,



Fig. 31L

Excavators Fig 31L
RI-71135
Excavators
Fig 31L,



Fig. 32L

Excavators Fig 32L
RI-71136
Excavators
Fig 32L,



Cleoid / Discoid
RI-71137
No. 3/6 Excavator, double end



Cleoid / Discoid
RI-71138
No. 89/92 Carver Discoid \",
octagonal handle

SCALERS



Fig. U15
Towner

Towner Fig U15
RI-72104
Scalers
Fig U15,



Fig. U15/33
Towner Jaquette

Towner Jaquette Fig U15/33
RI-72105
Scalers
Fig U15/33,



Fig. U15/30
Towner Jaquette

Towner Jaquette Fig 15/30
RI-72106
Scalers
Fig 15/30,



Fig H5/33

Fig H5/33
RI-72107
Scalers
Fig H5/33,



Fig H6/H7

Fig H6/H7
RI-72108
Scalers
Fig H6/H7,



Fig. 1/2

Fig 1/2
RI-72109
Scalers
Fig 1/2,

SCALERS



Fig. U15/33
Towner Jaquette

Towner Jaquette Fig U15/33
RI-72110

Scalers
Fig U15/33,



Fig. U15/30
Towner Jaquette

Towner Jaquette Fig U15/30
RI-72111

Scalers
Fig U15/30,

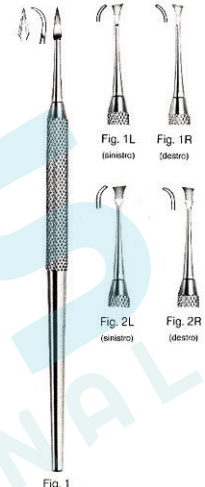

Fig. 1

Fig 1
RI-72112
Scalers
Fig 1,



Fig. 33

RI-72117
Scalers
Fig 33, Fig 31, Fig 32, Fig 34, Fig 35,



Fig. H5
Hygienist

Hygienist Fig H5
RI-72122
Scalers
Fig H5,

WAX & MODELLING CARVERS



P.K. THOMAS CARVERS FIG. 1
RI-73101

P.K.THOMAS WAX AND MODELLING
CARVERS FIG.1



P.K. THOMAS CARVERS FIG. 2
RI-73102

P.K.THOMAS WAX AND MODELLING
CARVERS FIG.2



P.K. THOMAS CARVERS FIG. 3
RI-73103

P.K.THOMAS WAX AND MODELLING
CARVERS FIG.3



P.K. THOMAS CARVERS FIG. 4
RI-73104

P.K.THOMAS WAX AND MODELLING
CARVERS FIG.4



P.K. THOMAS CARVERS FIG. 5
RI-73105

P.K.THOMAS WAX AND MODELLING
CARVERS FIG.5



P.K.THOMAS INSTRUMENTS
RI-73106

P.K.THOMAS WAX AND MODELLING
CARVERS FIG.5 SILVER

WAX & MODELLING CARVERS



P.K.THOMAS INSTRUMENTS
RI-73107
P.K.THOMAS WAX AND MODELLING
CARVERS FIG.4 RED



P.K.THOMAS INSTRUMENTS
RI-73108
P.K.THOMAS WAX AND MODELLING
CARVERS FIG.3 BLUE



P.K.THOMAS INSTRUMENTS
RI-73109
P.K.THOMAS WAX AND MODELLING
CARVERS FIG.2 GOLD



P.K.THOMAS INSTRUMENTS
RI-73110
P.K.THOMAS WAX AND MODELLING
CARVERS FIG.1 GREEN



RI-73111
FAHNENSTOCK Wax Carver 5 3/4" Knife,
small



RI-73112
FAHNENSTOCK Wax Carver 6 3/4" Knife, large

IMPRESSION TRAYS



Impression Trays
RI-74101
Impression Trays
66x52 mm,



Impression Trays
RI-74102
Impression Trays
62x50 mm,



Impression Trays
RI-74103
Impression Trays
64x50 mm,



Impression Trays
RI-74104
Impression Trays
65x46 mm,



Impression Trays
RI-74105
Impression Trays
69x54 mm,



Impression Trays
RI-74106
Impression Trays
65x46 mm,

IMPRESSION TRAYS



Impression Trays
RI-74107
Impression Trays
70x48 mm,



Impression Trays
RI-74108
Impression Trays
70x55 mm,



Impression Trays
RI-74109
Impression Trays
59x42 mm,



Impression Trays
RI-74110
Impression Trays
55x37 mm,



Impression Trays
RI-74111
Impression Trays
61x42 mm,



Impression Trays
RI-74112
Impression Trays
44 mm,

IMPRESSION TRAYS



Impression Trays
RI-74113
Impression Trays
44 mm,



Impression Trays
RI-74114
Impression Trays
44 mm,



Impression Trays
RI-74115
Impression Trays
66x52 mm,



Impression Trays
RI-74116
Impression Trays
65x46 mm,



Impression Trays
RI-74117
Impression Trays
59x42 mm,



Impression Trays
RI-74118
Impression Trays
69x54 mm,

IMPRESSION TRAYS



Impression Trays
RI-74119
Impression Trays
70x48 mm,



Impression Trays
RI-74120
Impression Trays
70x55 mm,



Impression Trays
RI-74121
Impression Trays
55x37 mm,



Impression Trays
RI-74122
Impression Trays
61x42 mm,



Impression Trays
RI-74123
Impression Trays
61x42 mm,



Impression Trays
RI-74124
Impression Trays
61x42 mm,

IMPRESSION TRAYS



Impression Trays
RI-74125
Impression Trays

DENTAL SYRINGES



RI-75101
Dental Syringes
55 x 37 mm,



RI-75102
Dental Syringes
55 x 37 mm,



Self Aspirating 1.8cc
RI-75103
Dental Syringes
55 x 37 mm,



Cylinder Cartridge Syringe
RI-75104
Dental Syringes
55 x 37 mm,



RI-75105
Dental Syringes
55 x 37 mm,

DENTAL SYRINGES



RI-75107
Dental Syringes
55 x 37 mm,



CW 1.8cc
RI-75108
Dental Syringes
55 x 37 mm,



RI-75109
Dental Syringes
55 x 37 mm,



RI-75110
Dental Syringes
55 x 37 mm,



RI-75111
Dental Syringes
55 x 37 mm,



RI-75112
Dental Syringes
55 x 37 mm,

DENTAL SYRINGES



RI-75113
Dental Syringes
55 x 37 mm,



RI-75118
Dental Syringes
Fig .1, Fig .2, Fig .3,



Dental Syringes
RI-75119
AspiraPlus
1.8 ml,



Dental Syringes
RI-75120
Dental Syringes
1.8 ml,



Dental Syringes
RI-75122
Dental Syringes
1,8 ml,



Dental Syringes
RI-75124
Dental Syringes
1,8 ml,

DENTAL SYRINGES



Dental Syringe
RI-75132
1 ml,

DENTAL SYRINGES



Dental Syringes
RI-75126
Dental Syringes
1,8 ml,



Dental Syringes
RI-75127
Dental Syringes
1,8 ml,

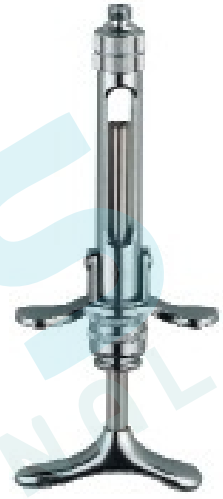

Dental Syringe
RI-75128
AspiraPlus
1.8 ml,



Dental Syringe
RI-75129



Dental Syringe
RI-75130



Dental Syringe
RI-75131

CAVITY PREPARATION

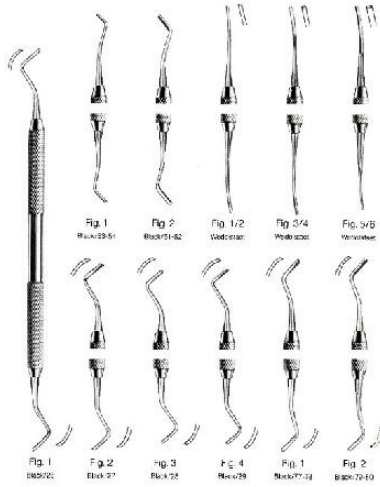

Wedge
RI-76101

Cavity Preparation
Fig 1, Fig 2, Fig 3, Fig 4, Fig 1/2, Fig 3/4, Fig 5/6,

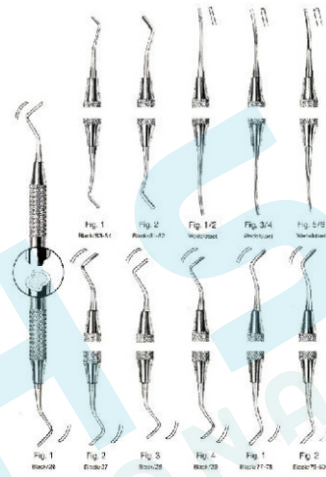

Wedge
RI-76112

Cavity Preparation
Fig 1, Fig 2, Fig 3, Fig 4, Fig 1/2, Fig 3/4, Fig 5/6,

EXPLORERS & PROBES



11 Briault D/E Explorer
RI-77101

FIG. # 11 BRIAULT D/E EXPLORER. MADE OF SOLID STAINLESS STEEL HANDLE



11/12 Odu D/E Explorer
RI-77102

FIG. # 11/12 OLD DOMINION UNIVERSITY D/E EXPLORER. MADE OF SOLID STAINLESS STEEL HANDLE



11/12 Odu D/E After Five Explorer
RI-77103

FIG. # 11/12 ODU D/E AFTER FIVE EXPLORER. MADE OF SOLID STAINLESS STEEL HANDLE



2A Pigtail D/E Explorer
RI-77104

FIG. # 2A PIGTAIL D/E EXPLORER. MADE OF SOLID STAINLESS STEEL HANDLE



2H D/E Explorer
RI-77105

FIG. # 2H DE EXPLORER. MADE OF SOLID STAINLESS STEEL HANDLE



2R/2L D/E Explorer
RI-77106

FIG. # 2R/2L D/E EXPLORER. MADE OF SOLID STAINLESS STEEL HANDLE

EXPLORERS & PROBES



3 Pigtail D/E Explorer
RI-77107

FIG. # 3 PIGTAIL D/E EXPLORER. MADE OF SOLID STAINLESS STEEL HANDLE



3CH Cowhorn D/E Explorer
RI-77108

FIG. # 3CH COWHORN D/E EXPLORER. MADE OF SOLID STAINLESS STEEL HANDLE



3ES D/E Explorer
RI-77109

FIG. # 3ES DE EXPLORER. MADE OF SOLID STAINLESS STEEL HANDLE



5 D/E Explorer
RI-77110

FIG. # 5 D/E EXPLORER. MADE OF SOLID STAINLESS STEEL HANDLE



6/3 D/E Explorer
RI-77111

FIG. # 6/3 DE EXPLORER. MADE OF SOLID STAINLESS STEEL HANDLE



17 S/E Explorer
RI-77112

FIG. # 17 SE EXPLORER. MADE OF SOLID STAINLESS STEEL HANDLE

EXPLORERS & PROBES



23 Shepherd's Hook Explorer
RI-77113

FIG. # 23 SHEPHERD'S HOOK S/E
EXPLORER. MADE OF SOLID STAINLESS
STEEL HANDLE



3 S/E Explorer
RI-77114

FIG. # 3 SE EXPLORER. MADE OF SOLID
STAINLESS STEEL HANDLE



3A S/E Explorer
RI-77115

FIG. # 3A S/E EXPLORER. MADE OF
SOLID STAINLESS STEEL HANDLE



54 S/E Explorer
RI-77116

FIG. # 54 S/E EXPLORER. MADE OF
SOLID STAINLESS STEEL HANDLE

CROWN REMOVERS



RI-78101

A tips for MORREL Crown Remover



RI-78102

B tips for MORREL Crown Remover

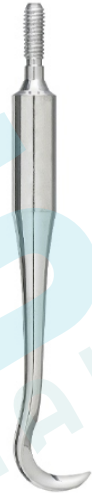

RI-78103

C tips for MORREL Crown Remover



RI-78104

MORREL Crown Remover, with 3 points



RI-78105

WYMAN Carbide Crown Gripper, 5 1/2" ,
without ratchet, with TC jaws

XRAYS HOLDERS



XRay Film Hangers 6 Clips

RI-79101

XRAY FILM HANGERS 6 CLIPS MADE OF
STAINLESS STEEL



XRay Film Hangers 10 Clips

RI-79102

XRAY FILM HANGERS 10 CLIPS MADE
OF STAINLESS STEEL

MATRIX RETAINERS



Matrix Retainer Ivory With Shield
RI-80107

MATRIX RETAINER IVORY WITH LATERAL SHIELD (JAW). STAINLESS STEEL



Matrix Retainer Cheek Protector
RI-80108

MATRIX BAND RETAINER CHEECK PROTECTOR. STAINLESS STEEL



Matrix Band Retainer Nystrom Left
RI-80109

MATRIX BAND RETAINER NYSTROM LEFT. STAINLESS STEEL



Matrix Band Retainer Nystrom Right
RI-80110

MATRIX BAND RETAINER NYSTROM RIGHT. STAINLESS STEEL



Matrix Band Retainer Siqveland (Ash Narrow)
RI-80111

MATRIX BAND RETAINER SIQVELAND (ASH NARROW). STAINLESS STEEL



Matrix Band Retainer Siqveland (Ash Wide)
RI-80112

MATRIX BAND RETAINER SIQVELAND (ASH WIDE). STAINLESS STEEL

MATRIX RETAINERS



Matrix Retainer Toffilemire
RI-80101

MATRIX BAND RETAINER TOFFILEMIRE.
AVAILABLE IN STRAIGHT & CONTRA.
STAINLESS STEEL



Toffilemire Matrix Retainer Junior / Child
RI-80102

MATRIX BAND RETAINER TOFFILEMIRE
JUNIOR / CHILD. AVAILABLE IN
STRAIGHT & CONTRA. STAINLESS
STEEL



Toffilemire Matrix Retainer Senior / Adult
RI-80103

MATRIX BAND RETAINER TOFFILEMIRE
SENIOR / CHILD. AVAILABLE IN
STRAIGHT & CONTRA. STAINLESS
STEEL



Toffilemire Matrix Retainer Universal
RI-80104

MATRIX BAND RETAINER TOFFILEMIRE
UNIVERSAL. AVAILABLE IN STRAIGHT &
CONTRA. STAINLESS STEEL



Matrix Band Retainer Ivory 8
RI-80105

MATRIX BAND RETAINER IVORY 8,
AVAILABLE IN 5MM, 6MM, 7MM.
STAINLESS STEEL



Matrix Band Retainer Ivory Plain
RI-80106

MATRIX RETAINER IVORY PLAIN /
WITHOUT LATERAL SHIELD (JAW).
STAINLESS STEEL

MATRIX RETAINERS



Matrix Band Retainer Ivory Didner
(Adjustable)
RI-80113
Matrix Band Retainer Ivory Didner
(Adjustable)



Matrix Retainer Ivory Separator
RI-80114

MATRIX BAND RETAINER IVORY
SEPARATOR. STAINLESS STEEL



Matrix Retainer Elliotte Separator
RI-80115

MATRIX RETAINER ELLIOTE
SEPARATOR. STAINLESS STEEL



Matrix Retainer Ivory 8 N
RI-80116
MATRIX BAND RETAINER IVORY 8N.
MADE OF STAINLESS STEEL



Matrix Retainer Didner 8 P
RI-80117
MATRIX BAND RETAINER IVORY 8P.
MADE OF STAINLESS STEEL

ARTICULATORS

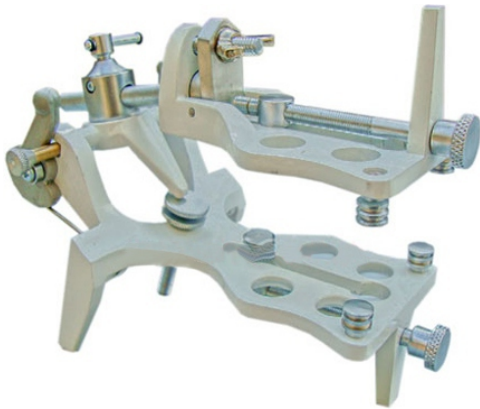

PLASTERLESS ARTICULATOR GALETTI (WHITE)
RI-81101

HIGH TECH PLASTERLESS ARTICULATOR GALETTI WITH ADJUSTABLE SCREWS AT REARS & FRONT. SOLIDLY CONSTRUCTED OF METAL ALLOY CASTING. ALL ANATOMICAL MOVEMENTS POSSIBLE



Vibratory Polished Articulator Galetti
RI-81102

GALETTI ARTICULATOR IS SOLIDLY CONSTRUCTED OF METAL ALLOY CASTING. EASY TO USE, ALLOWING QUICK FIXATION OF MODEL. IMMEDIATE ADJUSTMENT OF THE OCCLUSAL & CORRECTS IMULATION OF CENTRAL RELATION. ALL ANATOMICAL MOVEMENTS POSSIBLE. VIBRATORY POLISHED



ANATOMICAL ARTICULATOR (ASA)
RI-81103

ANATOMICAL ARTICULATOR WITH BEARING ROD & INCISIVE PIN, 4 MOUNTING PLATES & SUPPORTING BACKPIN FOR 45° VIEW, OPENING 125°, INTERCONDYLAR DISTANCE 110 MM SOLIDLY CONSTRUCTED OF METAL ALLOY CASTING



UNIVERSAL ARTICULATOR
RI-81104

ANATOMICAL ARTICULATOR, MADE OF ALUMINUM PRESSOFUSION OF ONLY 590/GR OF WEIGHT. REALIZED FOR EASY VISIBILITY TO THE LINGUAL SURFACE & FOR A PERFECT STABILITY ALSO IN RESERVED POSITION. THE RETURN TO THE HINGS WITH RECALL SPRING IS AUTOMATIC. OPENING 125°, WITH 4 MOUNTING PLATES (AVAILABLE



Gnatus Pro JP30 Articulator

RI-81105

The Gnatus Pro JP30 Articulator offers the best performance with an excellent degree of accuracy. Its functionality makes easier both the procedures of taking and transferring the patient's records and the process of mounting the models. Records can be taken and transferred accurately and fast. Light and resistant, makes operation easier. Its symmetrical and centered opening and closing



ANATOMICAL ARTICULATOR
RI-81106

ANATOMICAL ARTICULATOR WITH INCISIVE PIN, 4 MOUNTING PLATES AND SUPPORTING BACKPIN FOR 45° VIEW, OPENING 125°, INTERCONDYLAR DISTANCE 110 MM. – AVAILABLE IN ASSORTED COLOR

ARTICULATORS



KEYSTONE BLACK ARTICULATOR WIRED
RI-81107

KEYSTONE DELUXE UNIVERSAL TYPEA ARTICULATOR. INTERCHANGEABLE, INCISAL PIN INCLUDED, LATERAL EXCURSIONS.



KEYSTONE DELUXE MAGNET ARTICULATOR
RI-81108

KEYSTONE DELUXE MAGNETIC DENTURE ARTICULATOR WITH PLATES, INTERCHANGEABLE, INCISAL PIN INCLUDED. MAGNETIC SPLIT CASTING ENSURES EASY & EXACT SETTING, LATERAL EXCURSIONS

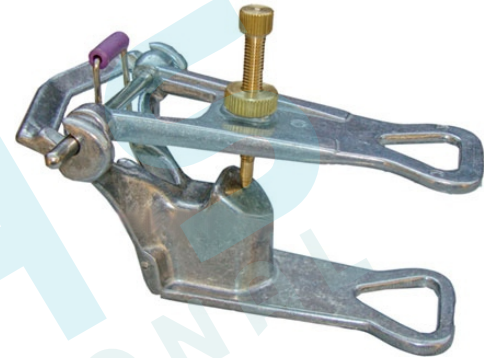

PROFESSIONAL OCCLUSOR ARTICULATOR
RI-81109

PROFESSIONAL OCCLUSOR, VIBRATORY POLISHED ARTICULATOR ALUMINUM, BRASS, STAINLESS STEEL



Magicart1 Articulator
RI-81110

LIGHTWEIGHT, HIGHQUALITY MAGIC ART ARTICULATOR SECURELY HOLDS QUADRANT MODELS, CONSERVE MATERIALS & TIME! QUICKLY & EASILY MOUNT PRECAST DENTAL MODELS WITH THE HIGH QUALITY. WITH MAGICART, YOU CAN SECURELY MOUNT & REMOVE ANY SIZE QUADRANT MODEL CASTS WITH AN EXCLUSIVE SIDE GRIP. SERRATED CCLAMPS LOCK MODELS TIGHTLY WITH A QUICK ADJUSTMENT &



FULL DENTURE ARTICULATOR (ROUND)
RI-81111

FULL DENTURE CHROME PLATED ARTICULATOR (3 SLOT ROUND)

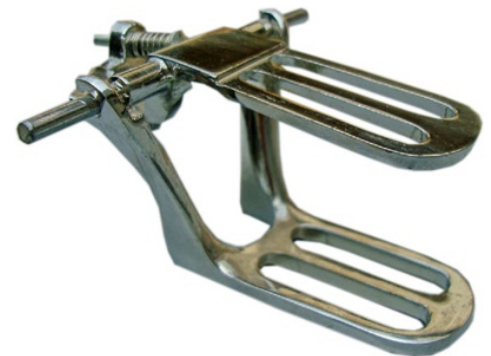

MODEL 'M' HI TOP STEPHAN ARTICULATOR
RI-81112

FULL DENTURE CHROMIUM PLATED ARTICULATOR. PROVIDES ADDITIONAL VERTICAL DIMENSION FOR ACCEPTANCE OF HIGHER MODELS. 49 WIDE AT THE JOINT & HAS A VERTICAL SPAN BETWEEN PARALLEL BOWS OF 25/8"



Chromium Plated Plain Round
RI-81113
Nickle Chromium Plated Plain Round
Articulator



UNIVERSAL ARTICULATOR (YELLOW)

RI-81114

UNIVERSAL ARTICULATOR OPENING 125°
WITH 4 MOUNTING PLATES CONDYLAR
INCLINATION FIXED AT 30°,
INTERCONDYLAR DISTANCE AT 110MM,
BENNET ANGLE FIXED AT 7°, DISTANCE
BETWEEN MOUNTING PLATES 85 MM.
SOLIDLY CONSTRUCTED OF METAL
ALLOY CASTING. Available In Assorted
Colors



FOSTER DENTURE ARTICULATOR

RI-81115

THIS ARTICULATOR IS EQUIPPED WITH
AN ADJUSTABLE ANTERIOR PIN STOP &
POSTERIOR SCREW STOP, AND
CONSTRUCTED OF A SLIGHTLY HEAVIER
GAUGE BRASS GIVING THE
ARTICULATOR A MORE SOLID FEEL.



FORK CHROME PLATED ARTICULATOR

RI-81116

NICKLE CHROMIUM PLATED
ARTICULATOR FORK PATTERN



HINGE ARTICULATOR FULL ARCH

RI-81117

AN ECONOMICAL & SIMPLE CHROMIUM
PLATED HINGE ARTICULATOR FOR
MOUNTING FULL ARCH CASES. LOW
BACK



QUADRANT / CROWNED BRIDGE
ARTICULATOR

RI-81118

BRASS HINGE CROWNED BRIDGE
ARTICULATOR FOR MOUNTING
QUADRANT CASES. CROWN & BRIDGE
ARTICULATOR IS POPULAR FOSTER # 57
DESIGN, ELIMINATES THE NEED TO
BREAK OFF MODELS

ARTICULATORS



UNIVERSAL ARTICULATOR (BLUE)

RI-81119

UNIVERSAL ARTICULATOR OPENING 125° WITH 4 MOUNTING PLATES CONDYLAR INCLINATION FIXED AT 30°, INTERCONDYLAR DISTANCE AT 110MM, BENNET ANGLE FIXED AT 7°, DISTANCE BETWEEN MOUNTING PLATES 85 MM. SOLIDLY CONSTRUCTED OF METAL ALLOY CASTING.



FOSTER / APEX # 2 ARTICULATOR

RI-81120

FOSTER / APEX # 2 ARTICULATOR, THE WIDTH AT THE JOINT IS 13/4" WITH A VERTICAL PARALLEL HEIGHT OF 21/8". THE SMALL SIZE OF THIS ARTICULATOR ALLOWS THE VERSATILITY TO USE FOR FULL OR PARTIAL WORK. THE FINISH IS BRIGHT CHROME. HIGH BACK



MORTIMERI OCULADER ARTICULATOR

RI-81121

PLAINLINE BALL BEARING MORTIMERI OCULADER ARTICULATOR. ALL FILLED WITH HIGH CARBON STEEL BALLS FOR SMOOTH SETTING & ARTICULATION OF DENTURE



MORTIMERII OCULADER ARTICULATOR

RI-81122

PLAINLINE BALL BEARING MORTIMERII OCULADER ARTICULATOR. ALL FILLED WITH HIGH CARBON STEEL BALLS. SEMIADJUSTABLE ARTICULATOR ALLOWS THE ESTABLISHMENT OF MORE ACCURATE OR CUSTOMISED LATERAL & PROTRUSIVE RI- WELL RI-CENTRIC OCCLUSION

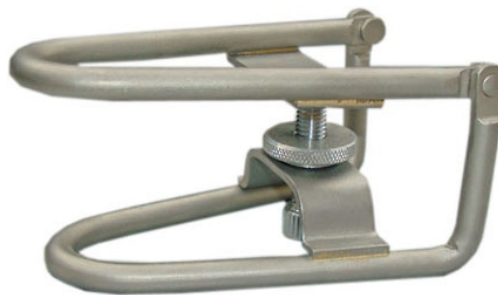

OCCLUSOR, WIRE ARTICULATOR

RI-81123

OCCLUSOR, WIRE ARTICULATOR STAINLESS STEEL & ALUMINUM



ASA Articulator 5002

RI-81124

ASA ARTICULATOR WITH LATERAL MOMENT. MADE OF ALUMINUM DIE CASTING WITH 2 MOUNTING PLATES. ALSO AVAILABLE IN VIBRATORY POLISHED PROCESS

ARTICULATORS



Model "A" Crescent Stephan Articulator
RI-81125

CRESCENT STEPHAN MODEL "A" ARTICULATOR IS USED FOR PARTIALS, CENTER SPRING WITH ADJUSTABLE TENSION, SMOOTH BRASS CASTINGS WITH NICKEL PLATING, CENTER BAR IN BOTH UPPER & LOWER BOW FOR MAXIMUM PLASTER RETENTION & STRENGTH. WIDTH AT THE JOINT OF 29, & VERTICAL SPAN WHEN BOWS ARE PARALLEL OF 2 1/8". REPRODUCE ALL ANATOMICAL MOVEMENTS. UPPER AND LOWER SECTIONS MAY BE SEPARATED OR ASSEMBLED QUICKLY. O



Bite Fork / Occlusal Alignment Plane
RI-81126

BITE FORK IS A RELIABLE INSTRUMENT FOR CHECKING THE CORRECT POSITION OF THE MASTICATORY PLANE, ACHIEVING PARALLELISM OF THE OCCLUSAL PLANE WITH THE CAMPER'S LINE & THE BIPUPILLARY LINE IS FUNDAMENTAL TO THE CONSTRUCTION OF DENTURES

INSTRUMENTS



RI-82101
Bandage and Utility Scissors, 7 1/2" (19.1 cm), needle destroyer, serrated blade, autoclavable



RI-82102
Plaster and Compound Knife



RI-82103
Soldering Tweezers, curved



RI-82104
SWISS Jeweler style Forceps, nonmagnetic stainless steel, style 3, narrow, fine, 4 3/4" (12.1 cm)



RI-82105
SWISS Jeweler style Forceps, nonmagnetic stainless steel, style 5, Super fine, 4 3/8" (11.2 cm)



RI-82106
SWISS Jeweler style Forceps, nonmagnetic stainless steel, style 7, fine, curved, 4 1/2" (11.4 cm)

INSTRUMENTS



Calipers
RI-82107
Calipers



Calipers
RI-82108
Calipers



Steel Ruler
RI-82109
Steel Ruler



Forceps for articulation paper
RI-82110
Forceps for articulation paper



CONTACT US

S.I.E OPP. PTCL EXCHANGE, NEAR SAEED SPORTS ,
TECHSIL & DISTRICT SIALKOT 51310 PAKISTAN

Phone: +92 306 6650340

Email: info@rahsintl.com

Web: www.rahsintl.com

